

# MATCHITECTURE®

**Big Rig**  
Camión-remorque  
Camión de 18 ruedas  
Großer Sattelschlepper  
Truck met oplegger  
Camion rimorchio

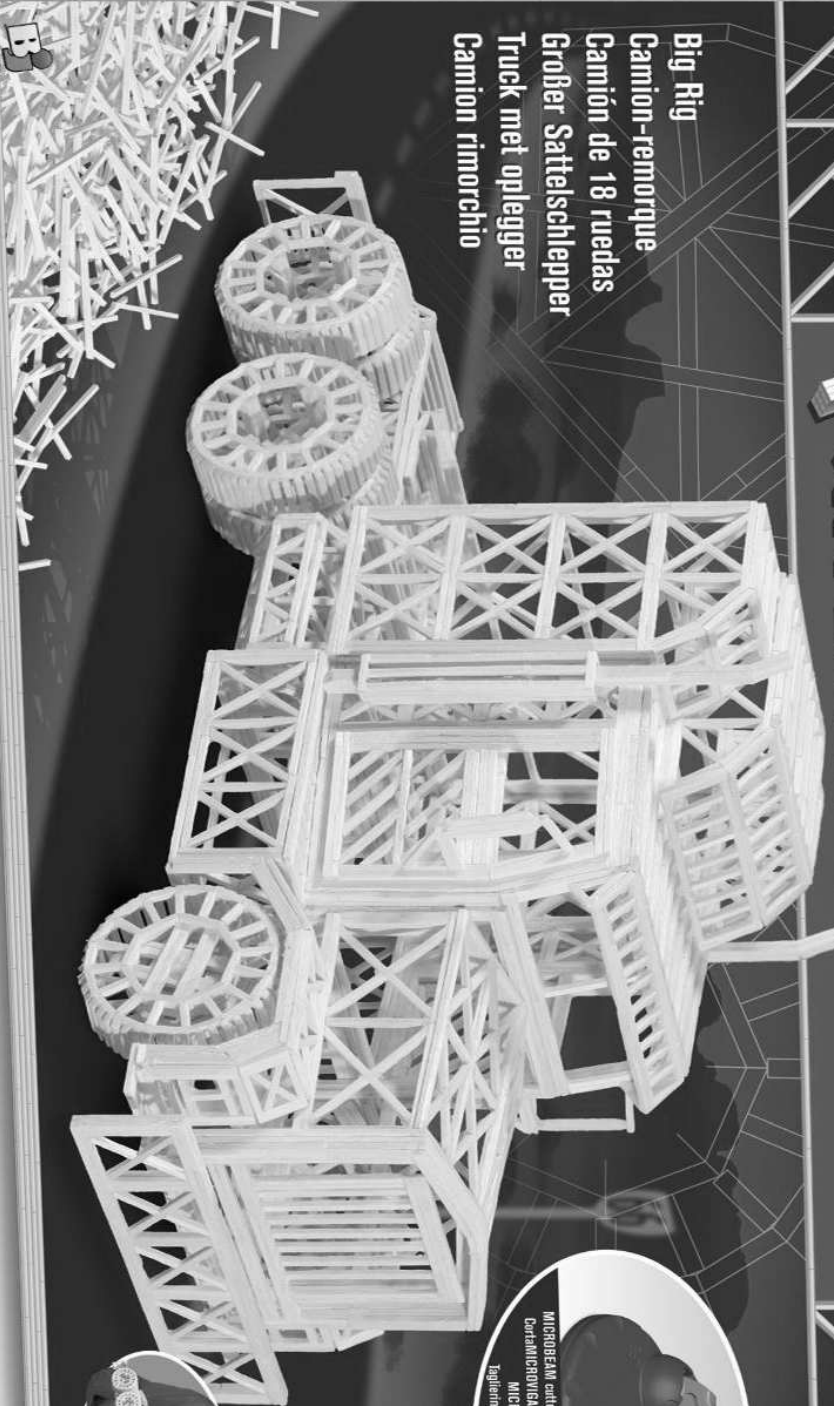

MICROBEAM, cutter • CONICO-MICROADMÄHNER •  
CERRAMICORINGEL • MICROSTRÄHE-SCHNEIDER •  
MICROBALK-sindler •  
Taglieterno per MICROTRAME



**MATCHITECTURE**  
Gold Rush Train  
Train de la ruée vers l'or



## Big Rig

It was in 1896, seven years after the appearance of the first motor automobile, that a gas-engine truck was born in Germany. In the years following the first few 30 hp, the first trucks were manufactured with flatbed beds. Then in 1923, the industry gave the truck a whole new appearance with the addition of a steering cabin. In America today, this type of truck has become the number one source of transport and a typical form of American freedom.

## Cambin-remorque

En 1896, sept ans après la naissance de la première voiture automobile motorisée, le ved en un Allemagne le camion à moteur à essence. Juste la première année, marchés, les premiers camions étaient une simple en leur pour camions. Plus en 1923, l'industrie suisse avec la cabine conduite, la America son apparence sans précédente. Aujourd'hui en Amérique type de camion est devenu le moyen de transport numéro un et une forme de liberté américaine.

## Cambion Remorque

En 1896, siete años después del nacimiento del primer automóvil motorizado, se fabricó en Alemania un camión con motor a gas. En los años posteriores a la primera guerra mundial, se fabricaron los primeros camiones con lanchas de gas. En 1923, la industria creó completamente la apariencia del camión apropiada una cabina de conducir. En América, actualmente, este tipo de camión es el medio de transporte número uno y un signo típico de la libertad americana.

## Großer Sattelschlepper

In der ersten sieben Jahre nach dem Erscheinen des ersten motorisierten Automobils wurde in Deutschland ein Lastwagen mit Gasmotor gebaut. In den Jahren, die auf den Ersten Weltkrieg folgten, wurden die ersten Lastwagen mit Selbstzündung hergestellt. Dann gab es Jahr 1923 die Bildung des Lastertrucks mit der Hinzuftüfung einer Schlenkbox an vorderer Achse. In Amerika wurde dieser Typ von Lastwagen zum Transportations-Mittel eines von vielen die Sparsamer Symbol für amerikanische Freiheit ist.

## Truck met oplegger

In 1896, zeven jaar na de verschijning van de eerste motor-af-voerde in Duitsland een vrachtwagen met benzine-motor gebouwd. In de jaren na de eerste wereldoorlog werden er eerste zelfontsteking met stalen behuizing gemaakt. In 1923 werd hier de laatste van de vrachtwagen met de toevoeging van heel nieuw ontwerp gebouwd. In Amerika is dit type van truck inmiddels het belangrijkste vervoermiddel en een typisch teken van de Amerikaanse vrijheid.

## Camión remolchó

El camión con motor a benzina è nato in Germania nel 1896, sette anni dopo la fabbricazione della prima automobile motorizzata. Negli anni seguenti la prima guerra mondiale, i primi camioni erano fabbricati con motore a benzina. Nel 1923 la cabina si aggiunse al camión in modo originale. Oggi in America questo tipo di camión è diventato il mezzo di trasporto più importante ed il simbolo della libertà americana.

## ビッグ・リグ

初めて現代的な自動車が登場してから10年経たぬ1896年、ドイツでガスエンジントラックが誕生しました。第一次世界大戦後の自由も、初回のトラックの建設は、布で作られていました。その後1923年、トラックに貨室が追加され、業界に於いてトラックは大きく外観を一変することになりました。今日、アメリカでは、この種のトラックが第一の輸送手段であり、アメリカの自由の象徴となっています。

# MATEHITECTURE

PLANS • PLANOS • PIANI • ZEICHNUNGEN • PLANNEN • 設計図

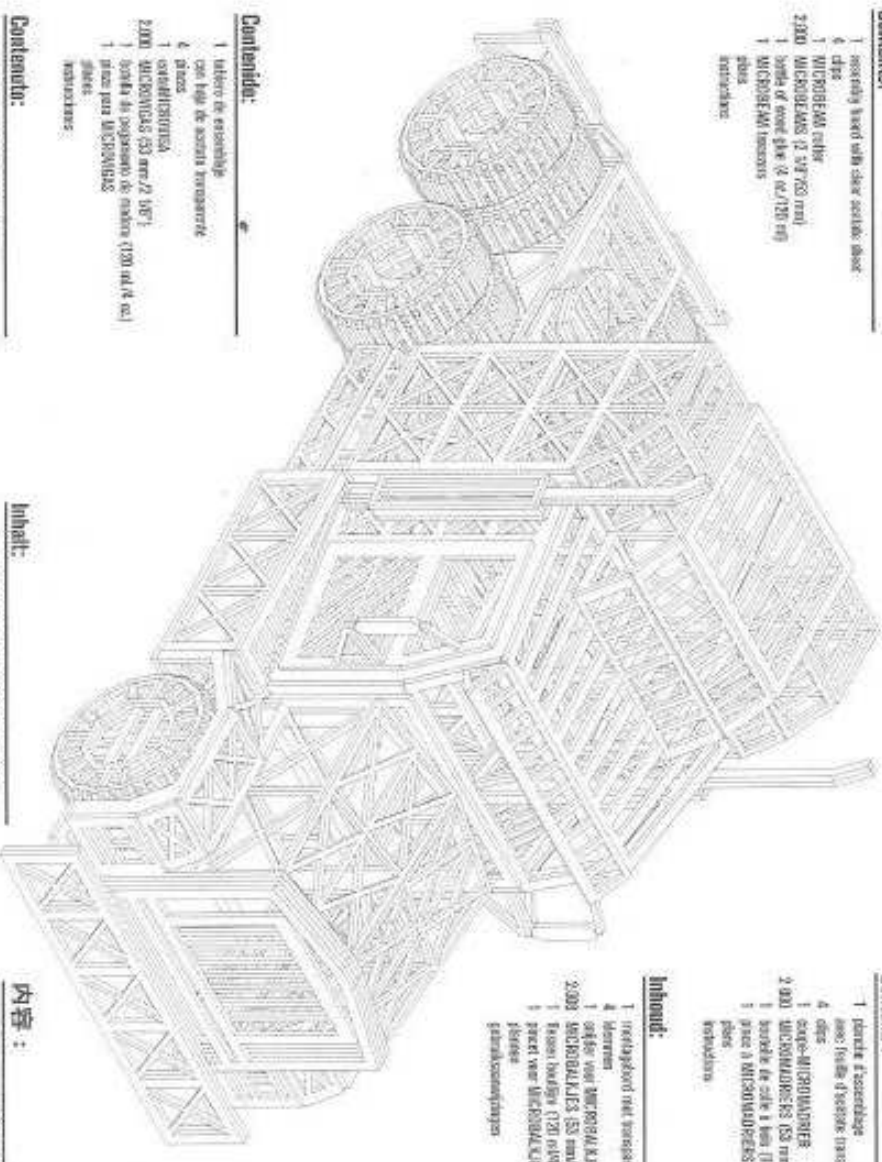

### Contents:

- 1 assembly hand with clear acrylic sheet
- 4 clips
- 1 MICROBEAM roller
- 2200 MICROBEAMS (2.97x53 mm)
- 1 bundle of wood glue (2 oz./120 mg)
- 1 MICROBEAM fasteners
- pins
- instructions

### Contenuto:

- 1 scatola foraschite
- 4 clip
- 1 rotolo MICROBEAM
- 2200 MICROBEAMS (53 mm/2.97")
- 1 scatola di colla a legno (120 mg/4 oz)
- 1 pezzo MICROBEAM FASTENERS
- pin
- istruzioni

### Inhoud:

- 1 montagebord met touwspannet heel van acetaat
- 4 klampen
- 1 rollet voor MICROBEAMS
- 2200 MICROBEAMS (53 mm/2.97")
- 1 flesje lijm (120 mg/4 oz)
1 stuk voor MICROBEAM FASTENERS
- spijkers
- gebruiksaanwijzing

### Contenido:

- 1 tablero de ensamblaje con hoja de acetato transparente
- 4 clips
- 1 carrete MICROBEAMS
- 2200 MICROBEAMS (53 mm/2.97")
- 1 bulto de pegamento de madera (120 mg/4 oz)
- 1 pieza para MICROBEAMS
- pasos
- instrucciones

### Contenuto:

- 1 tavola d'assemblaggio con foglio di acetato trasparente
- 4 clip
- 1 rotolo MICROBEAM
- 2200 MICROBEAMS (53 mm/2.97")
- 1 bottiglia di colla per legno (120 mg/4 oz)
- 1 pezzo per MICROBEAM
- pin
- istruzioni

### Inhalt:

- 1 montagebord met touwspannet heel van acetaat
- 4 klampen
- 1 rollet voor MICROBEAMS
- 2200 MICROBEAMS (53 mm/2.97")
- 1 flesje lijm (120 mg/4 oz)
- 1 stuk voor MICROBEAM FASTENERS
- spijkers
- gebruiksaanwijzing

### 内容:

- 1 透明シートと紐を固定するアクリル
- 4 クリップ
- 1 マイクロビームローラー
- 2200 マイクロビーム (53mm/2.97")
- 1 木工用接着剤 (120mg/4oz)
- 1 マイクロビームピンセット
- ピン
- 使用説明書

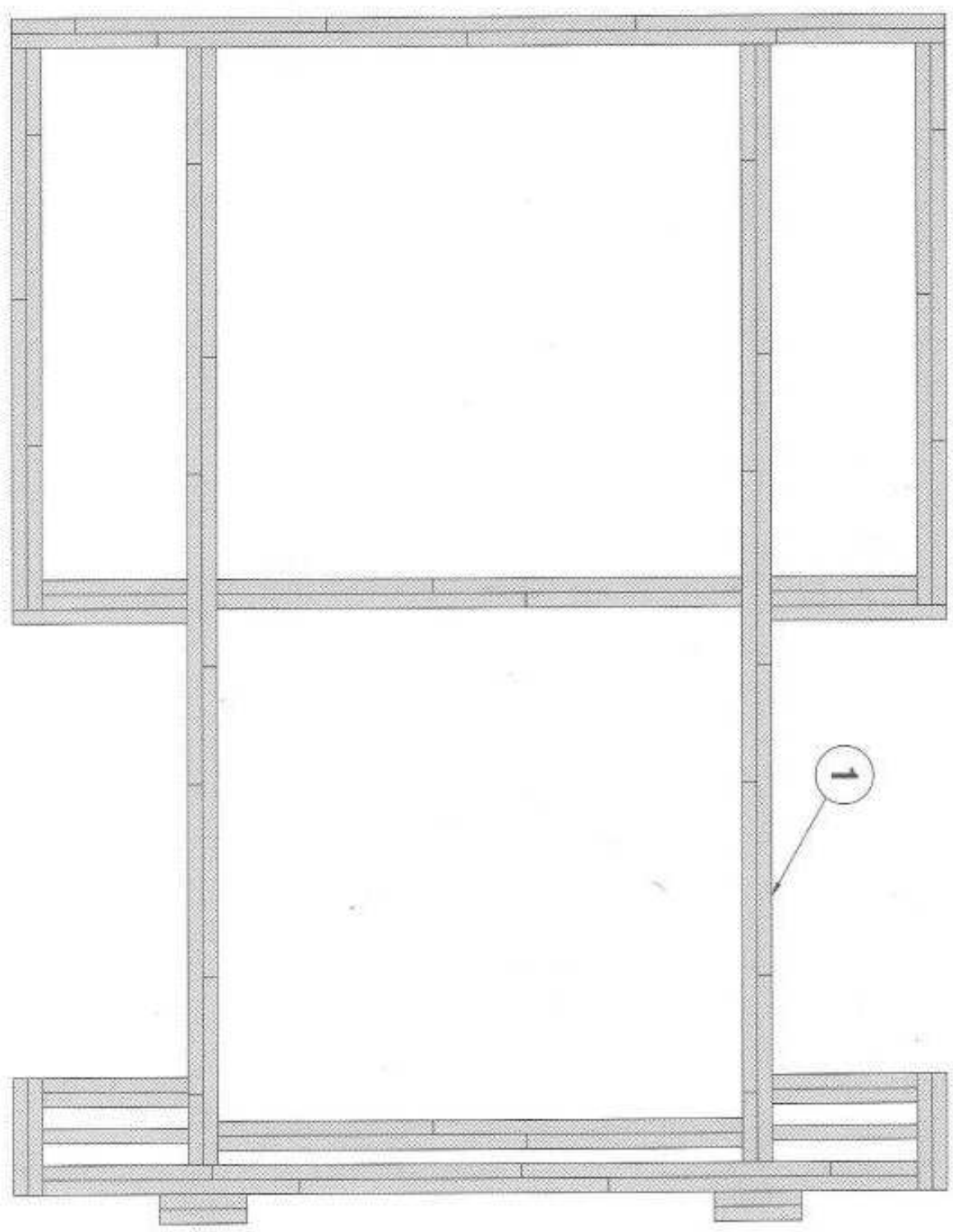

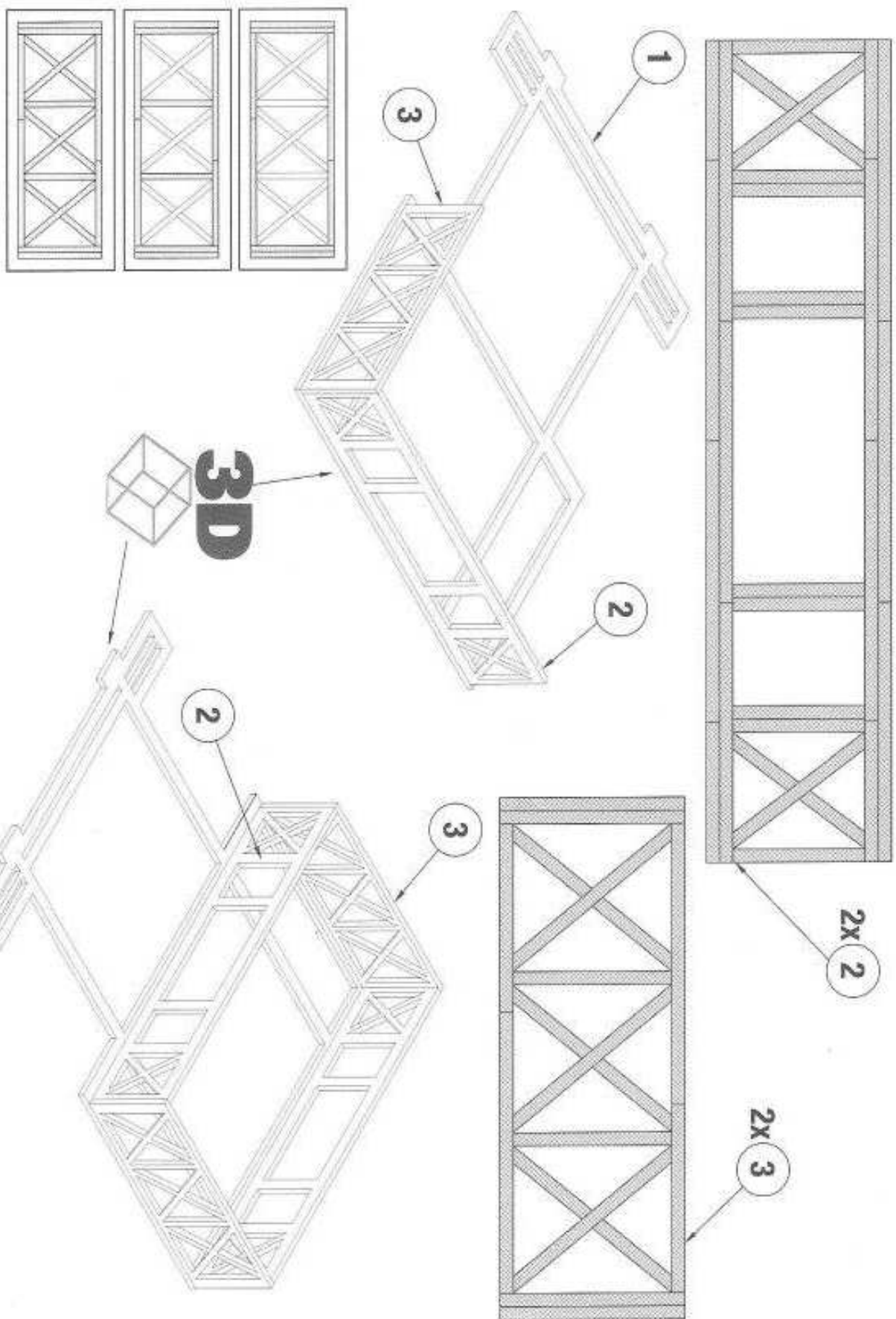

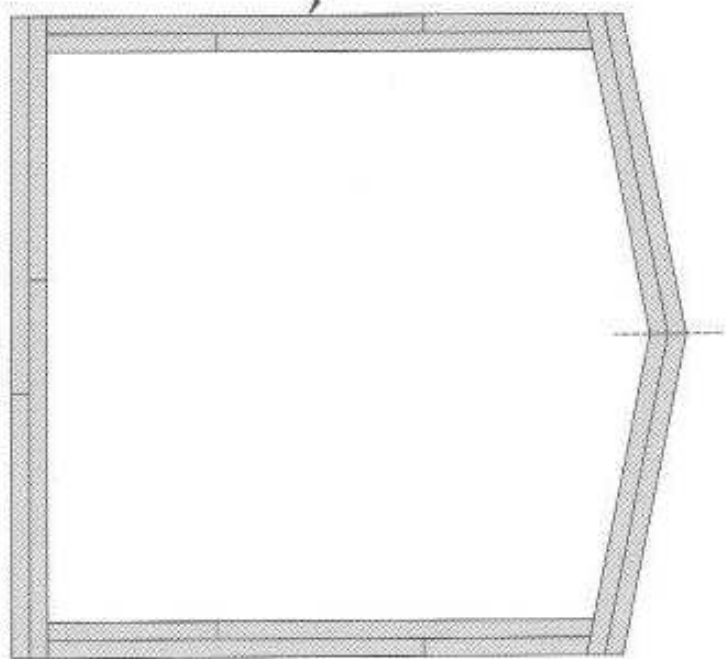
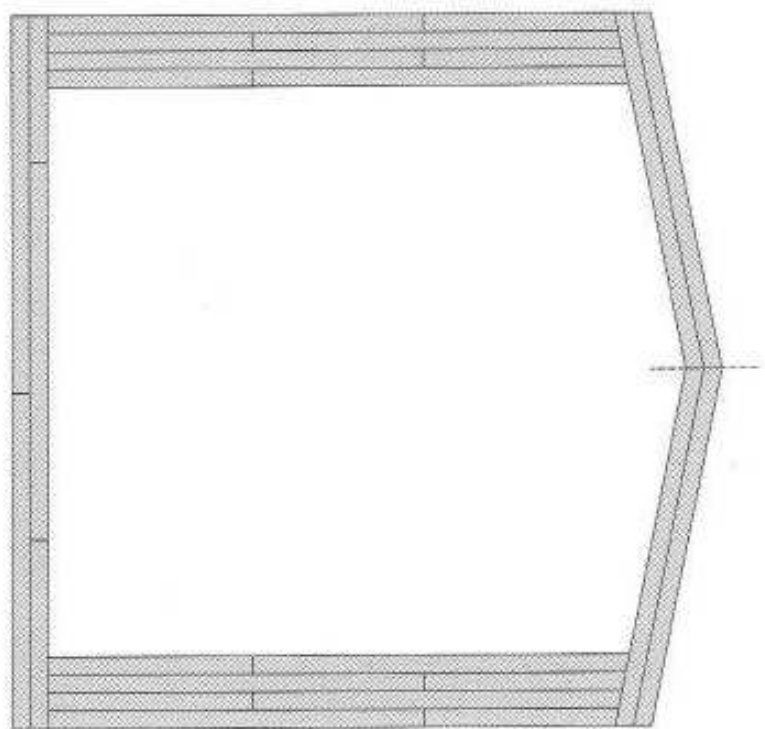

**3D**

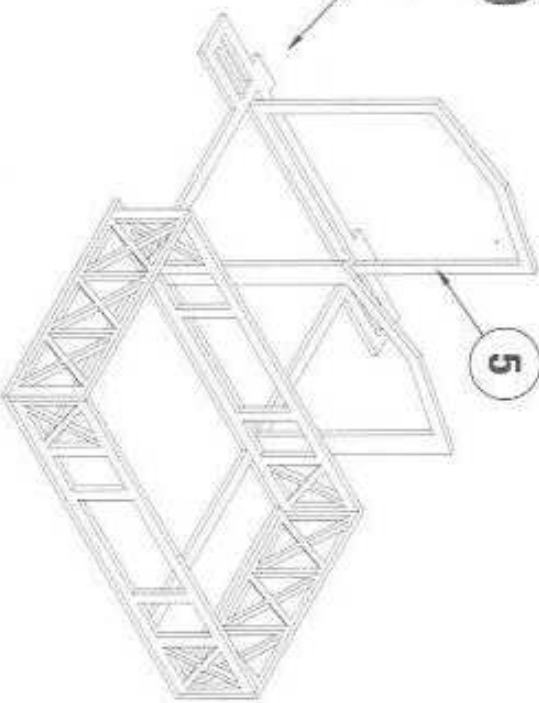
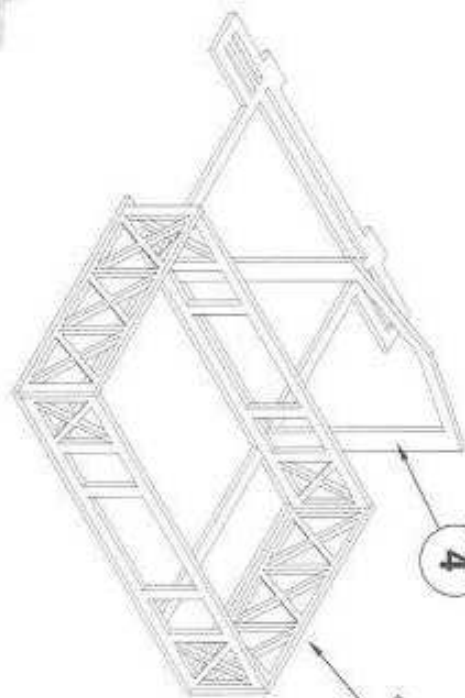

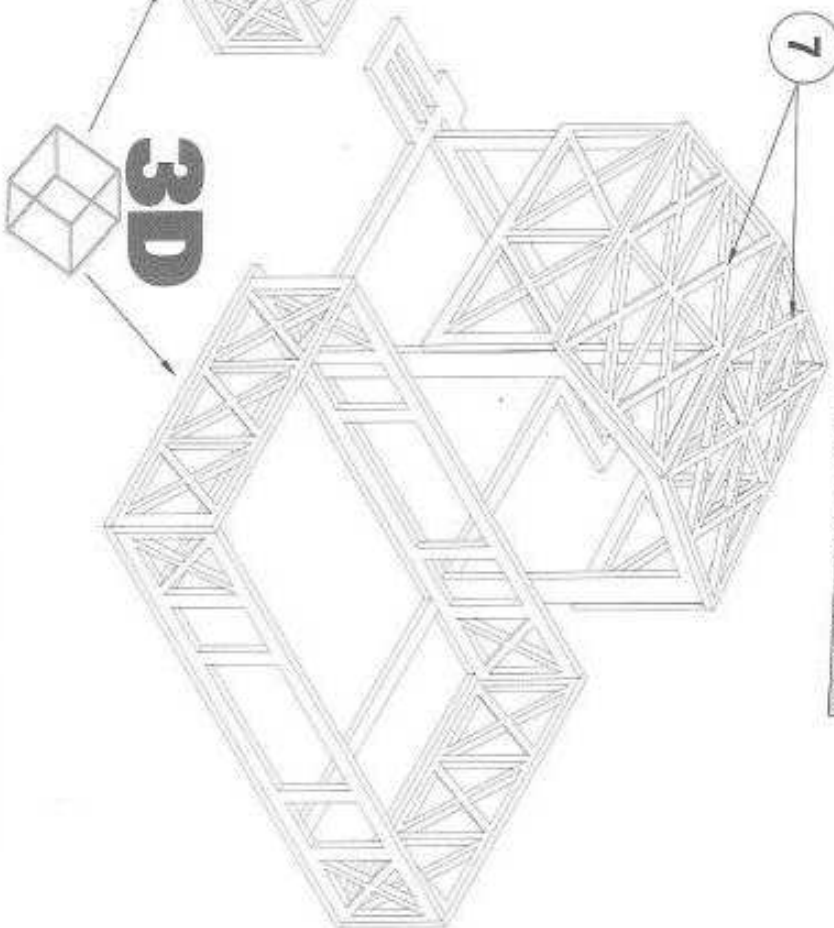
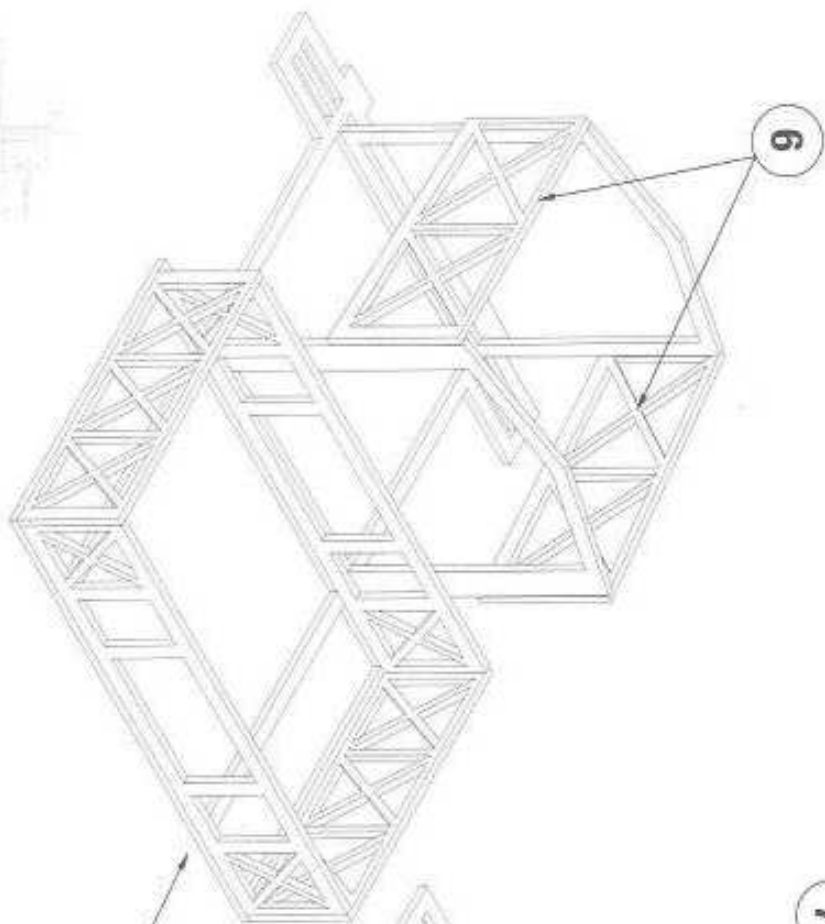
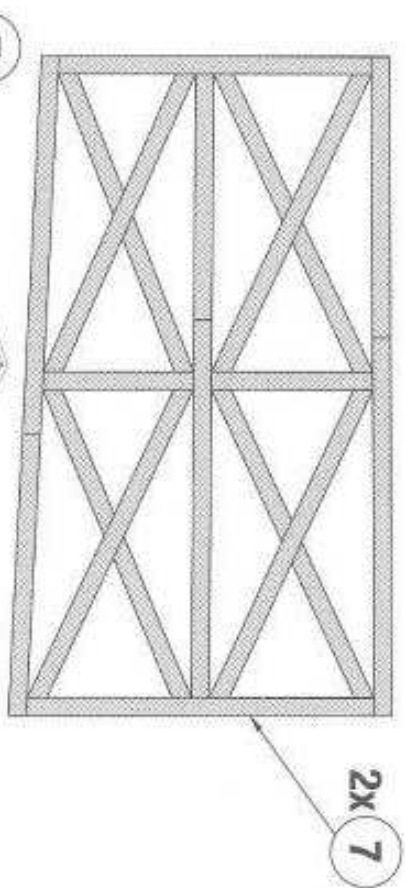
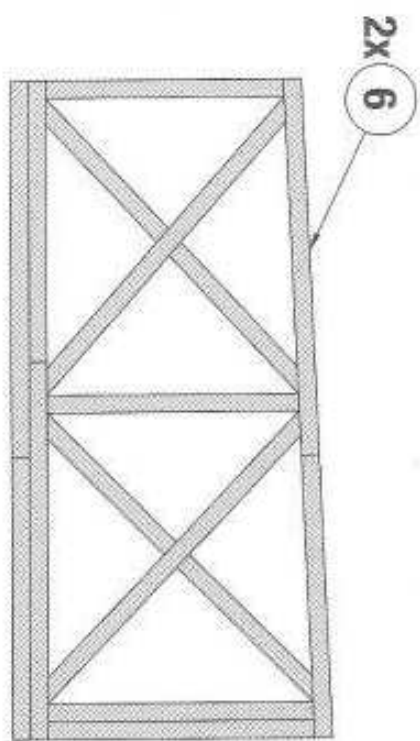

3D

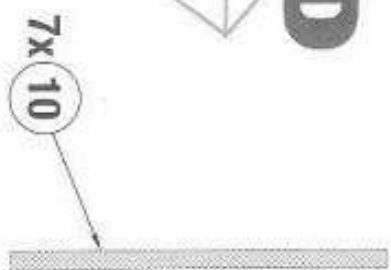
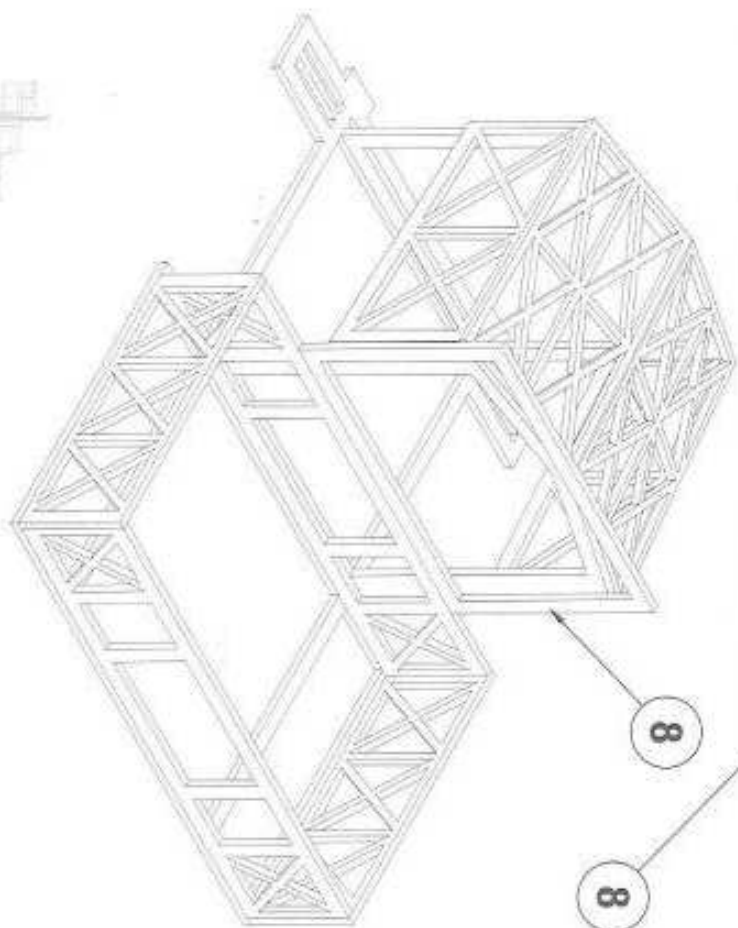
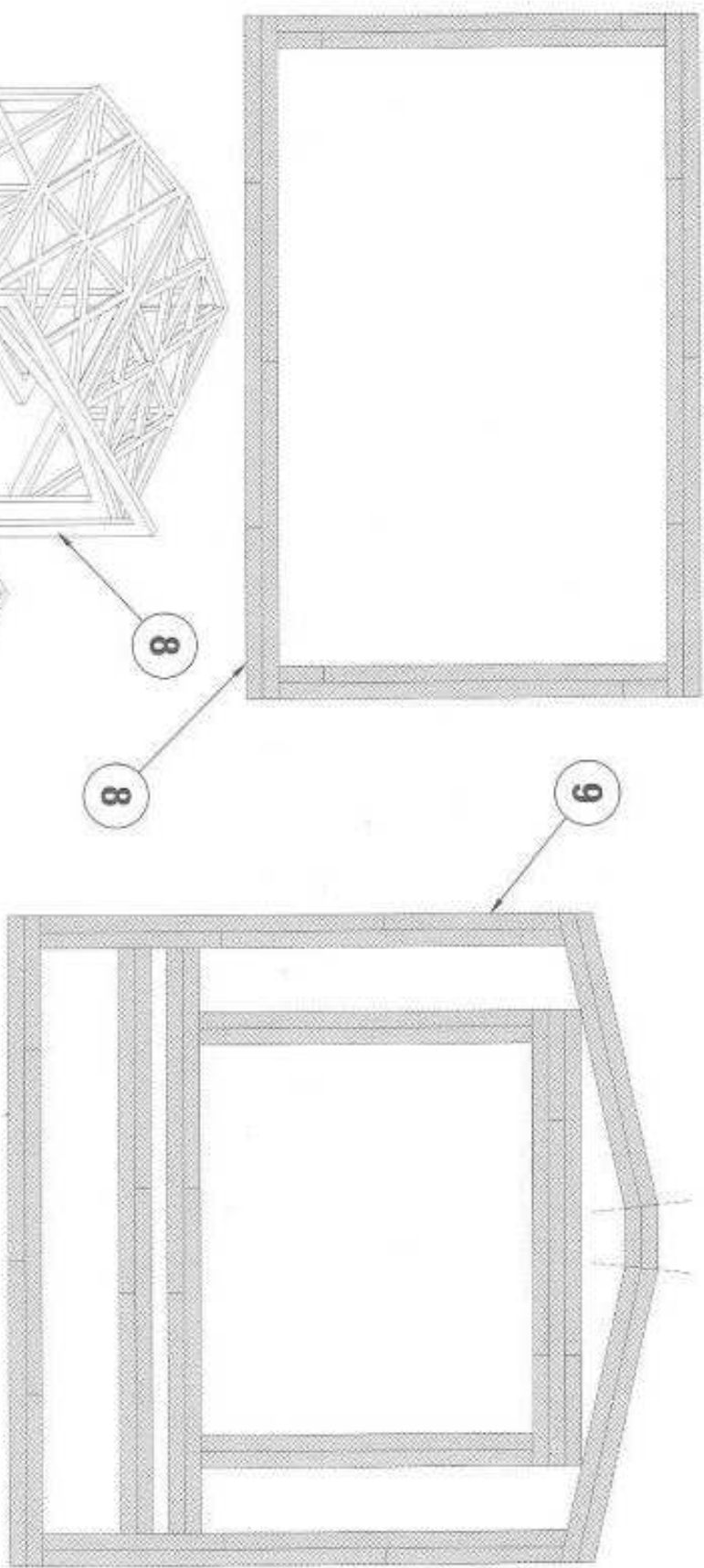

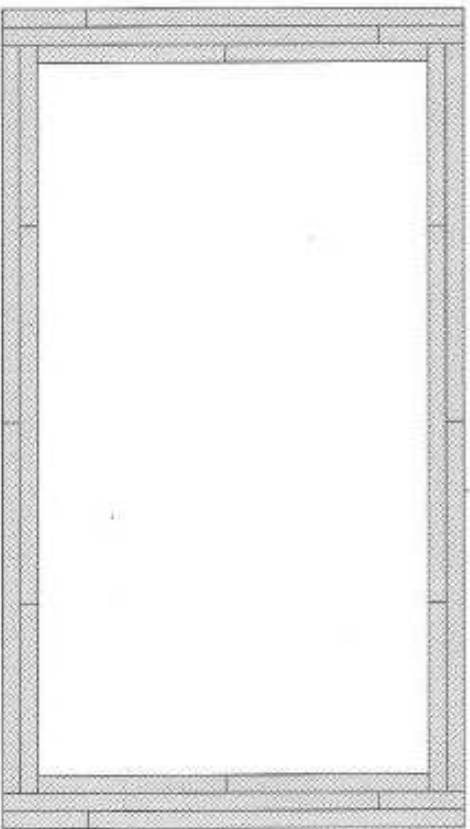
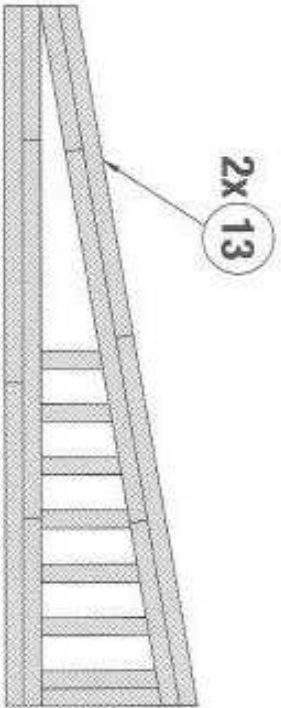
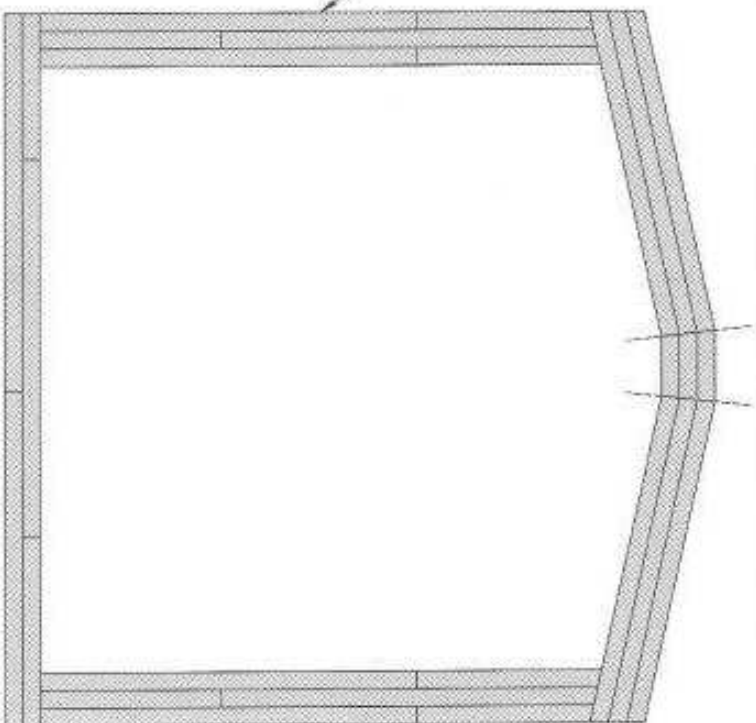
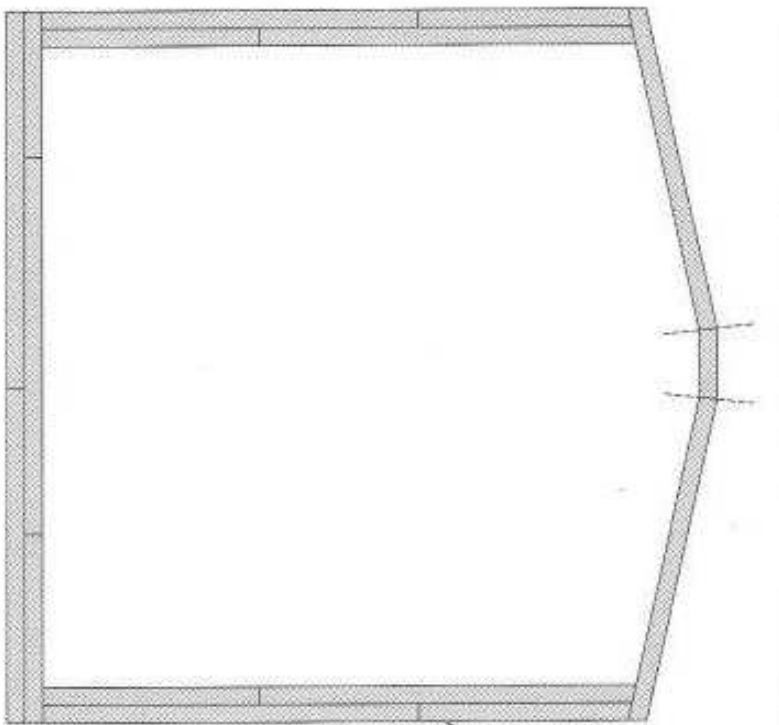

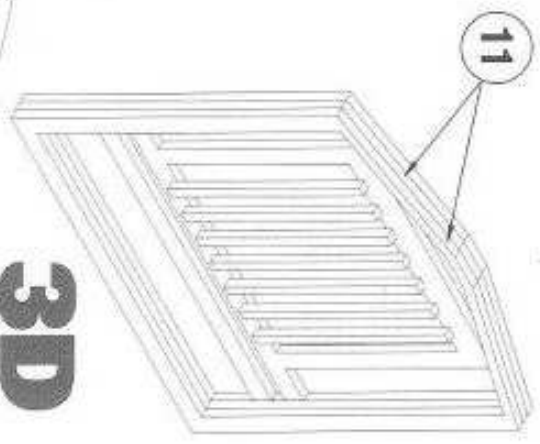
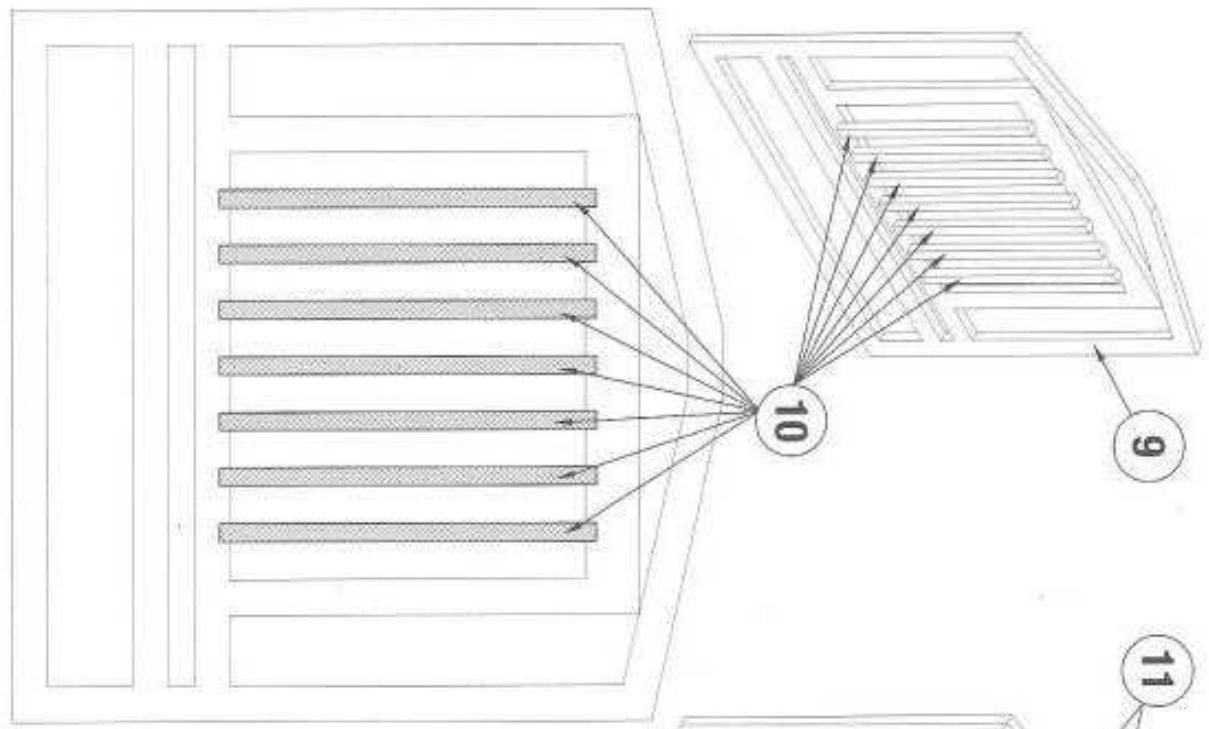

**3D**

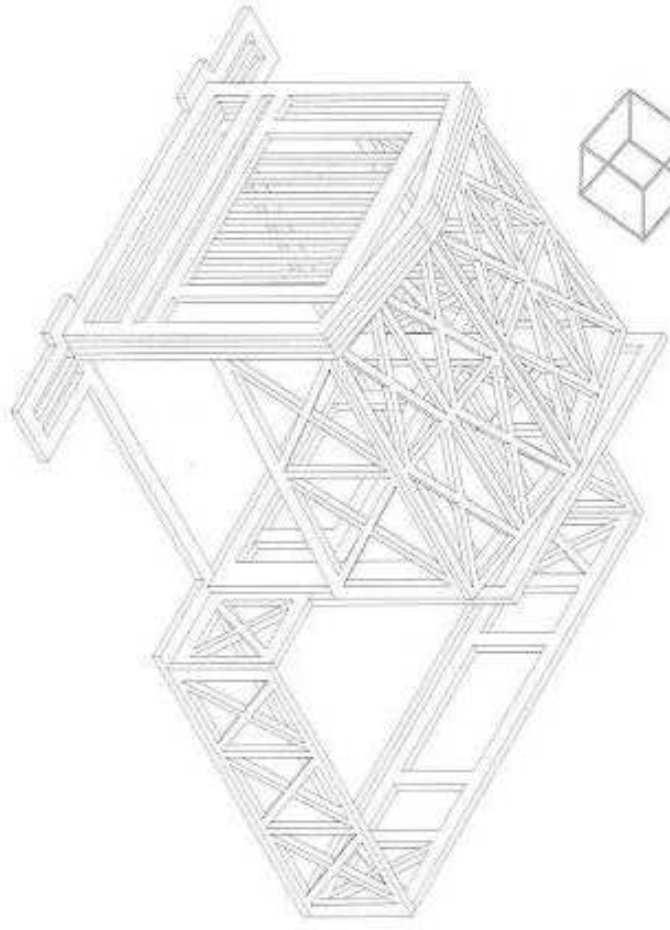
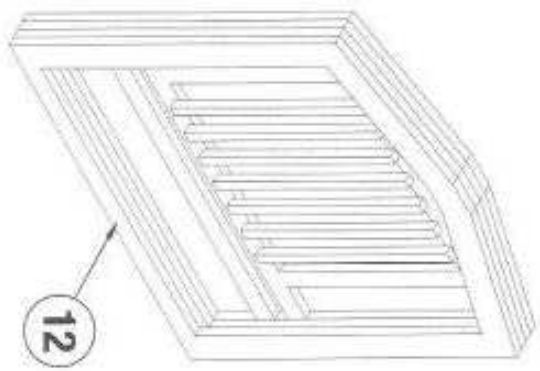

© 2004, Beyer Inc.

[www.machitecture.com](http://www.machitecture.com)

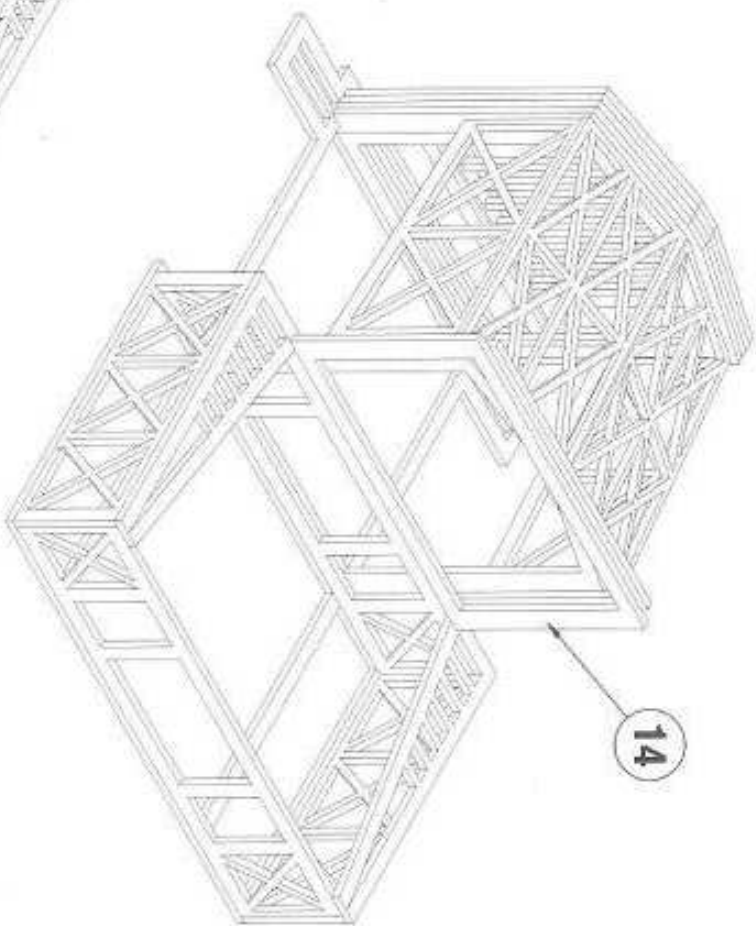
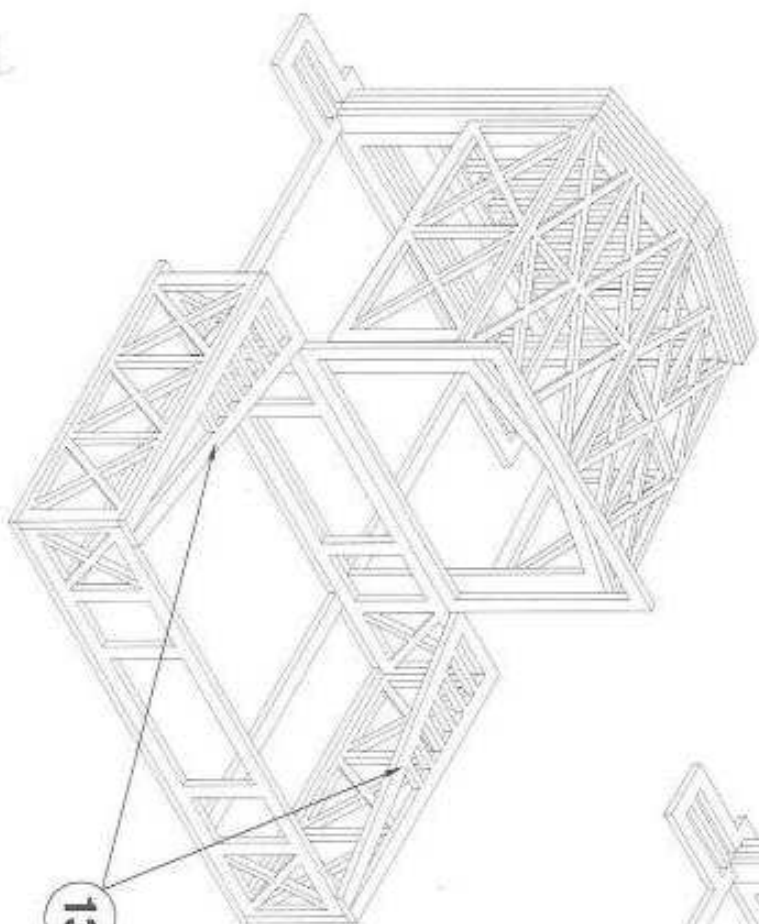
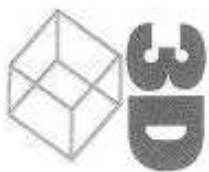

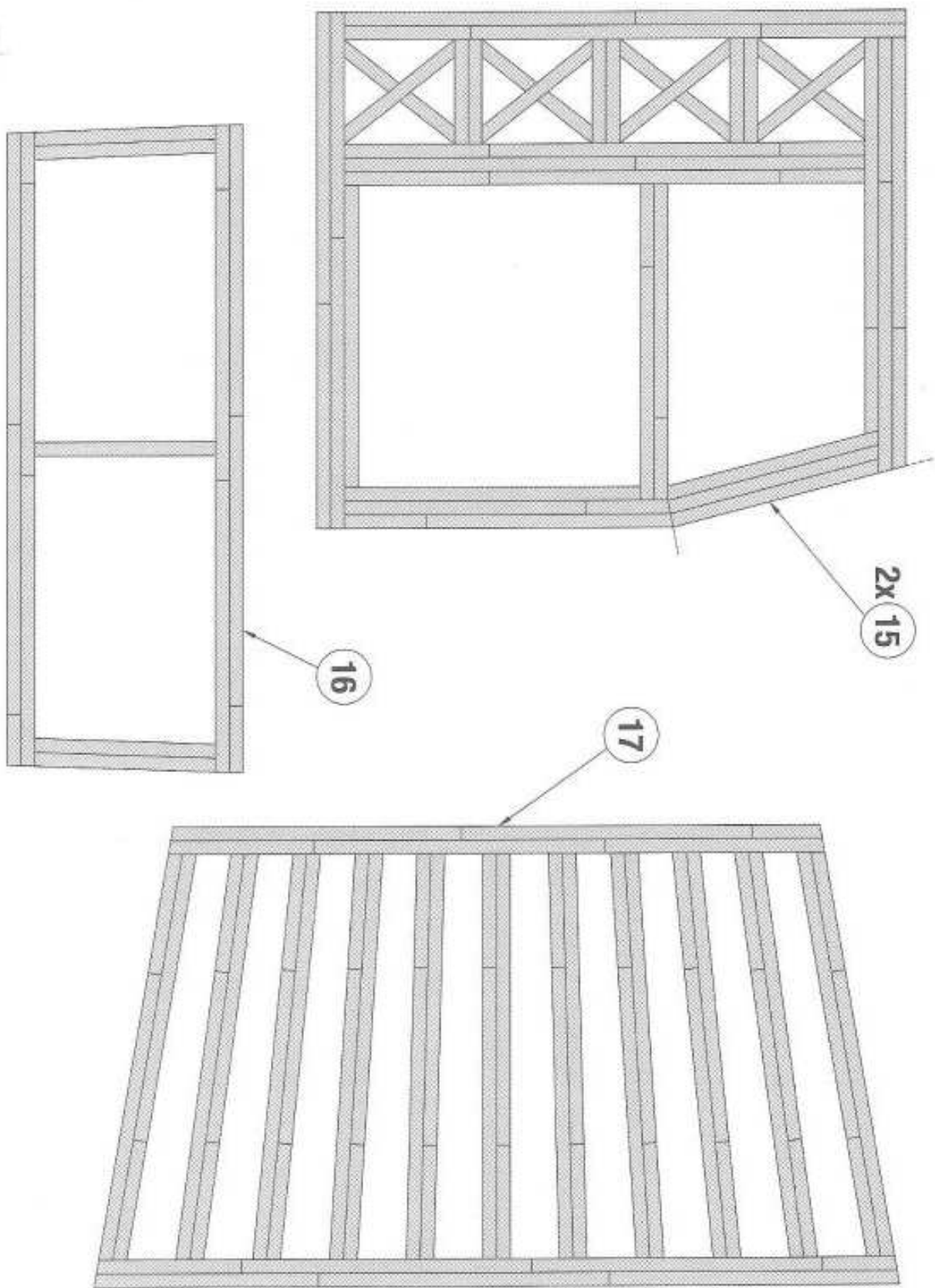

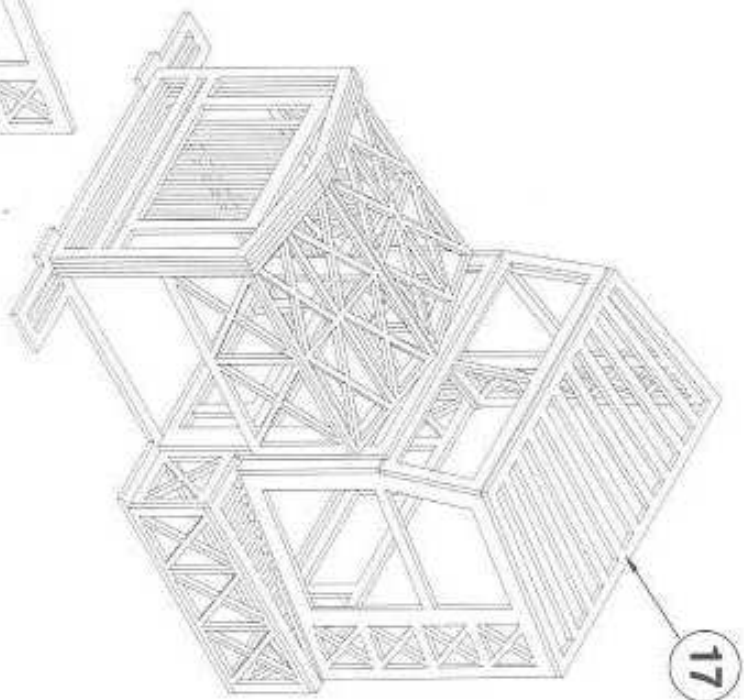
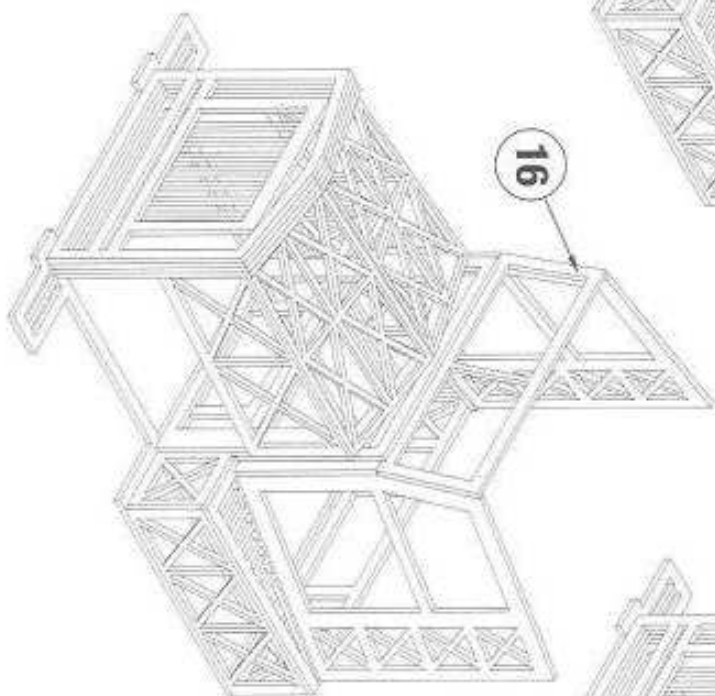
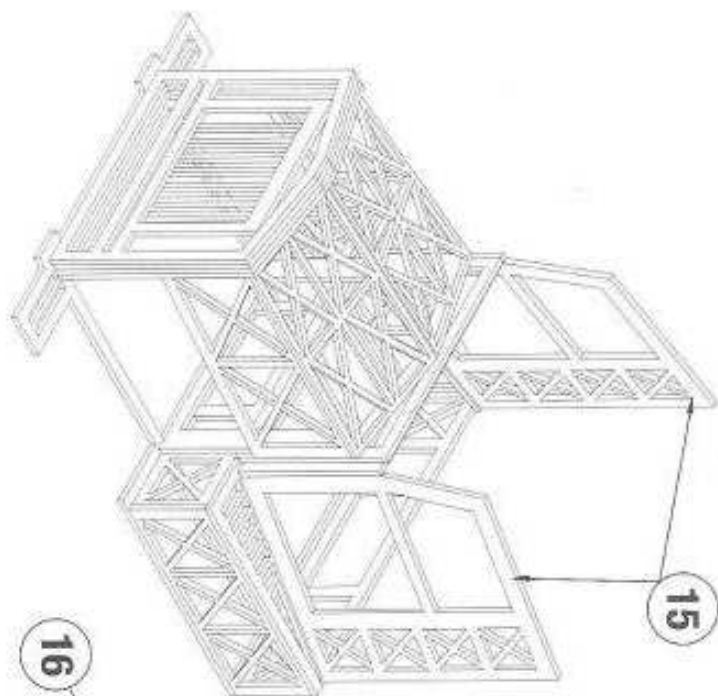

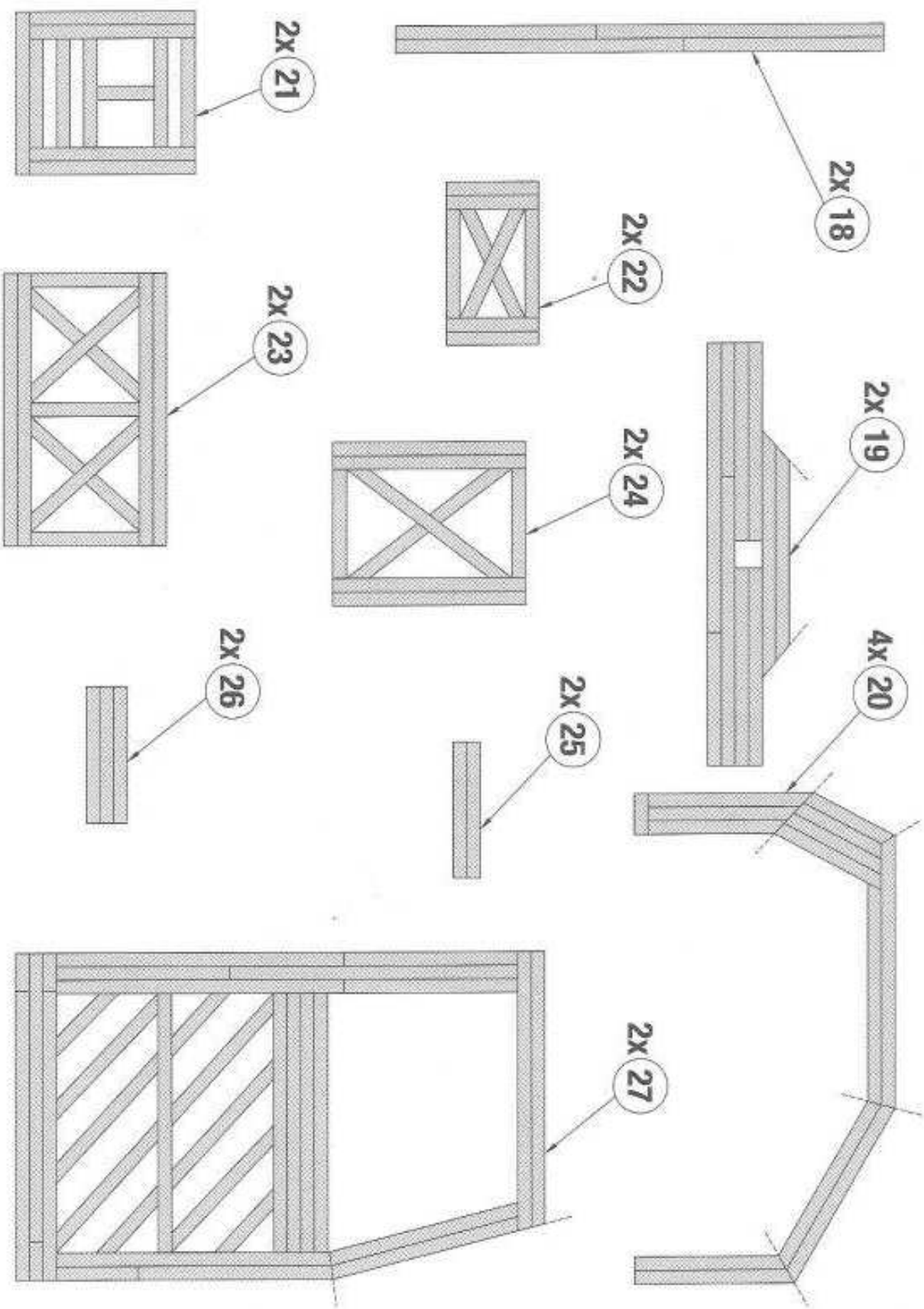

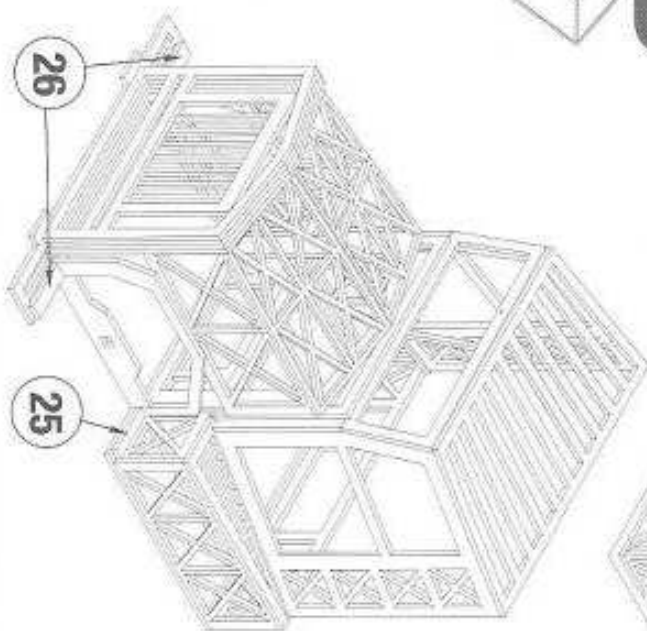
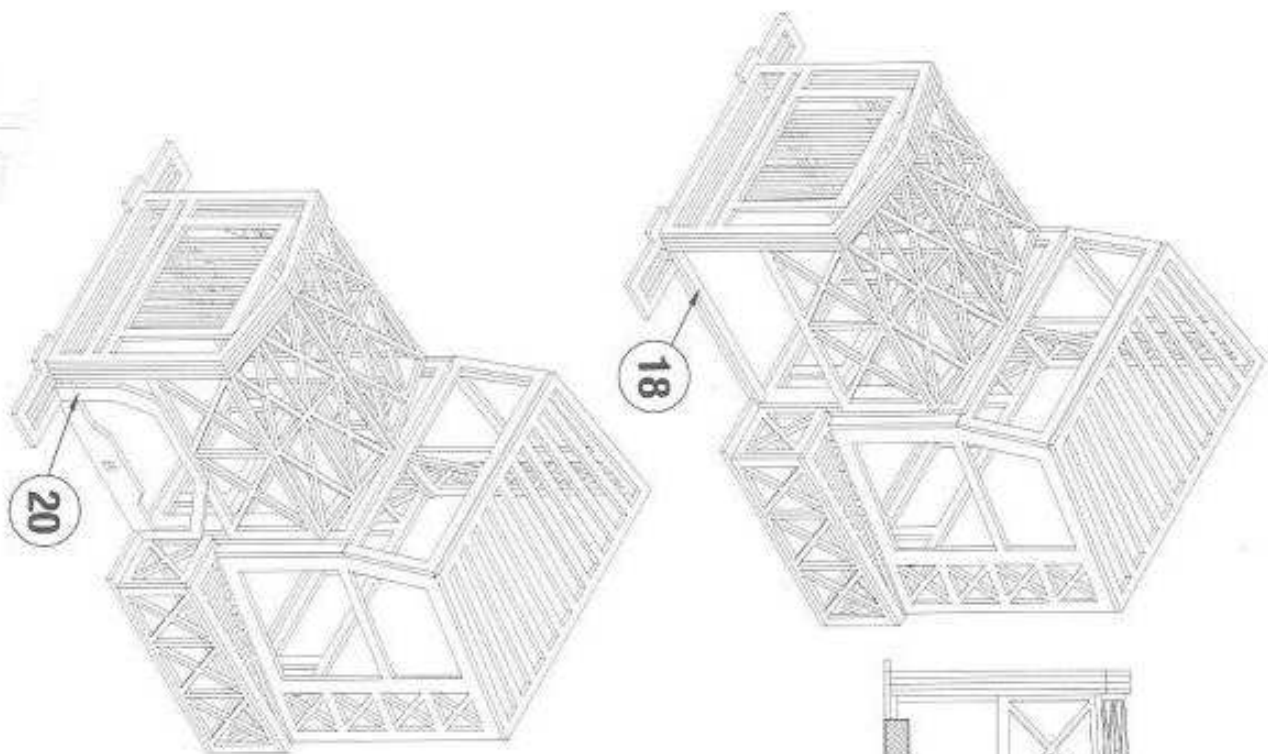

**3D**

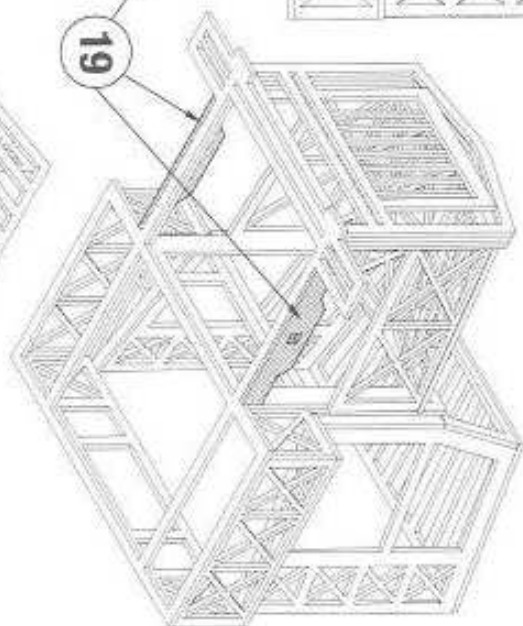
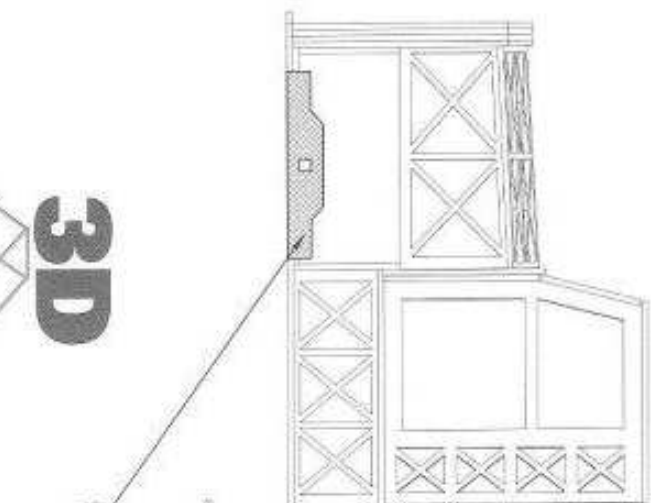

**3D**

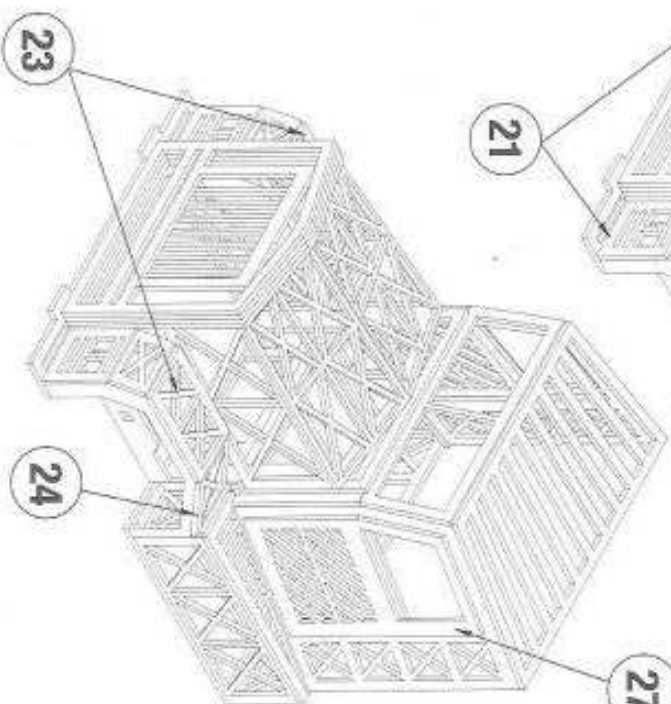
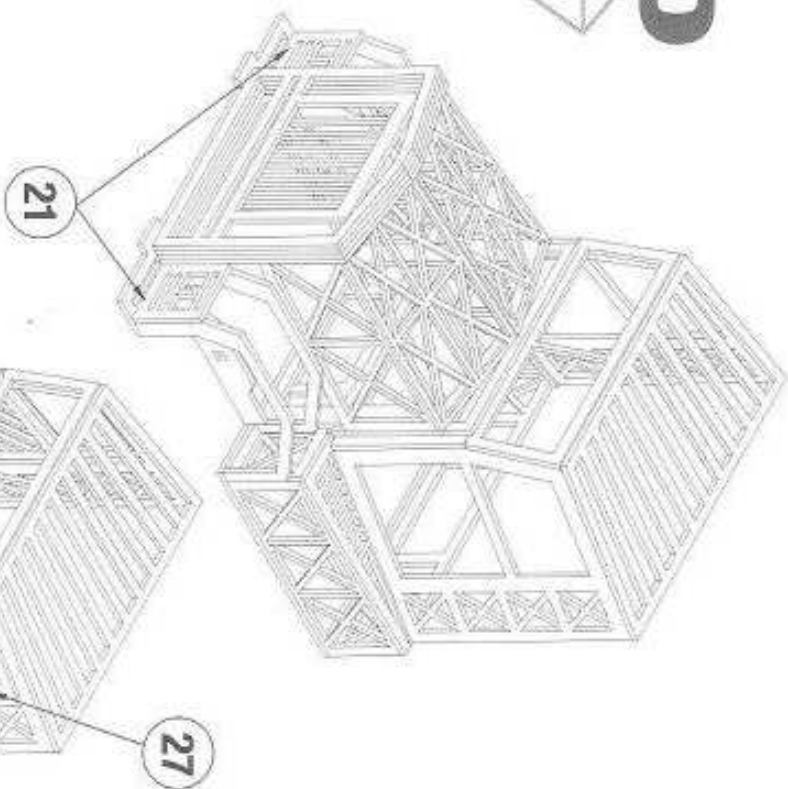
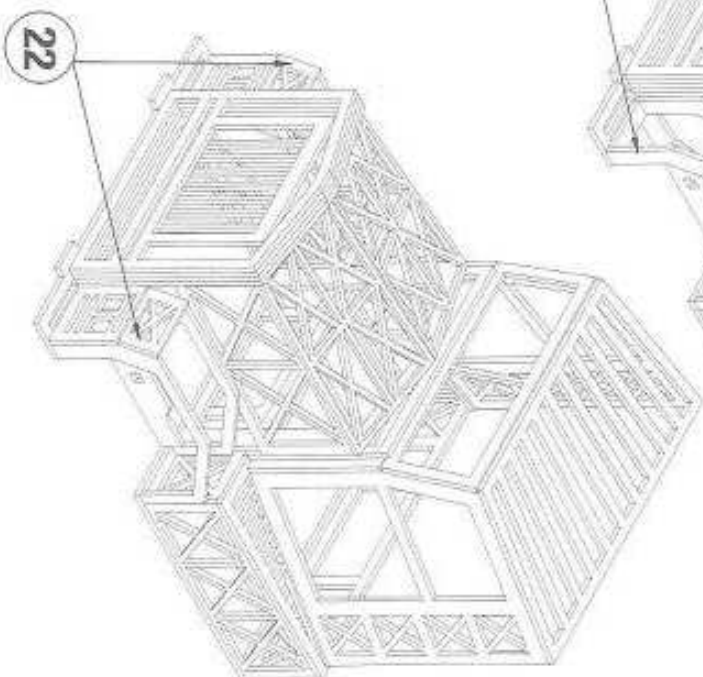
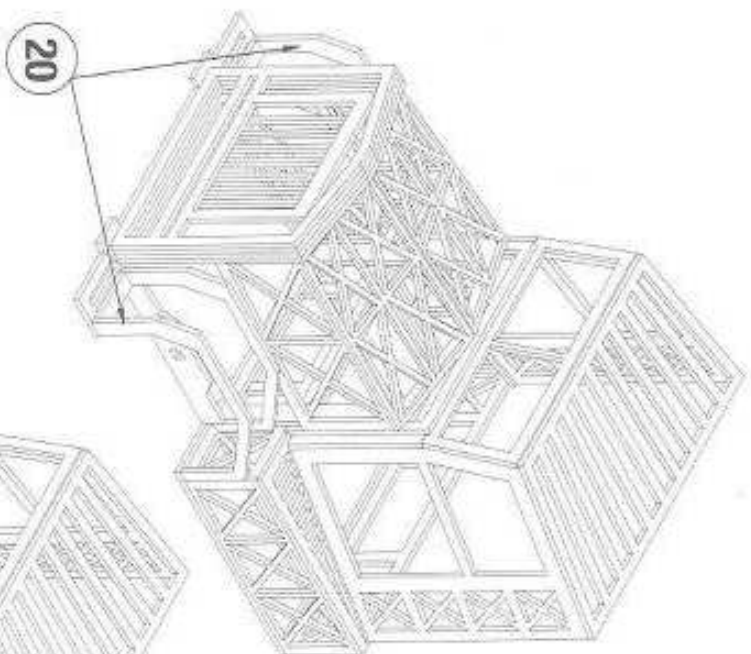

© 2004, Ripar, Inc.

[www.matechitecture.com](http://www.matechitecture.com)

**MATECHITECTURE**

**13** 44

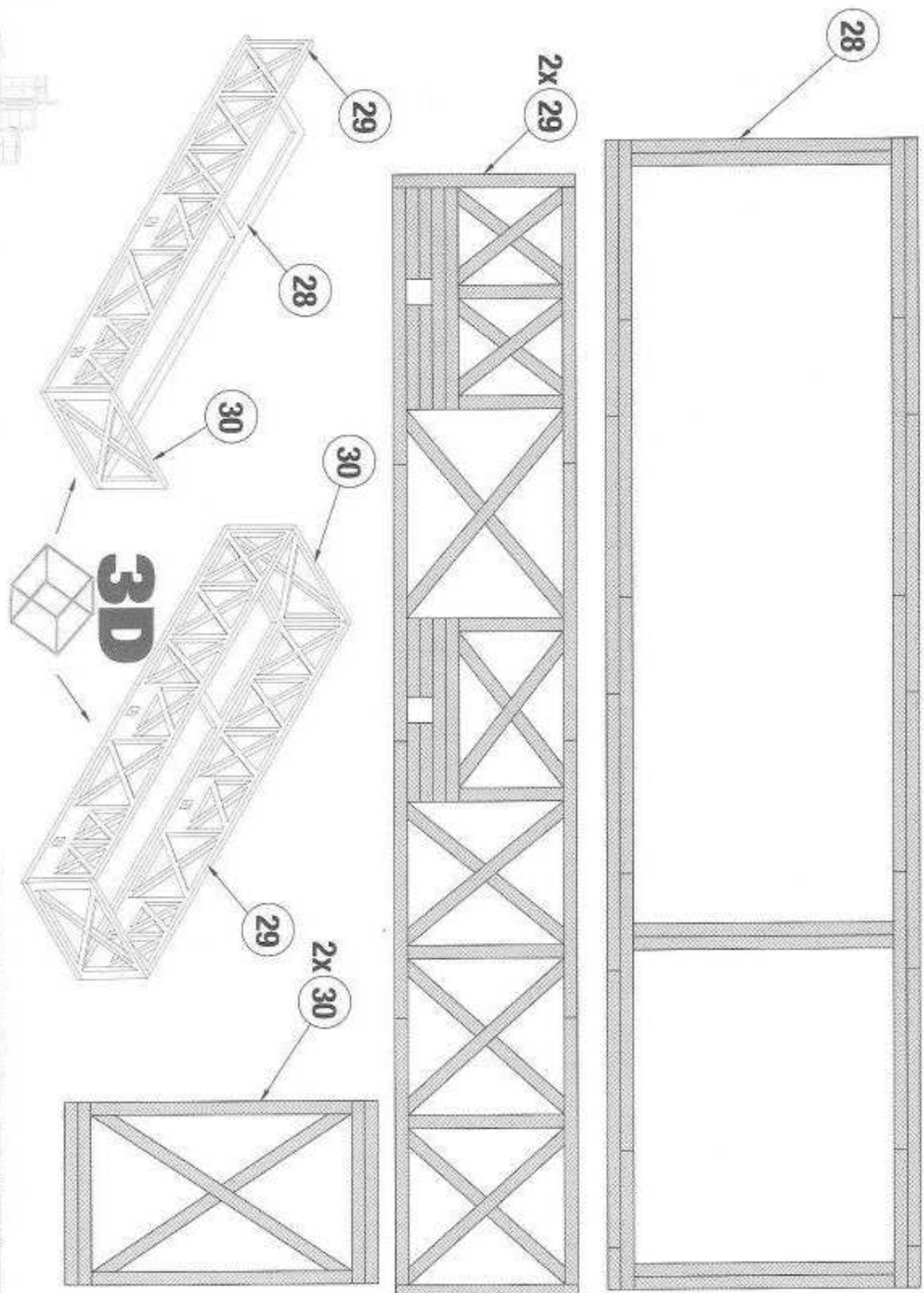

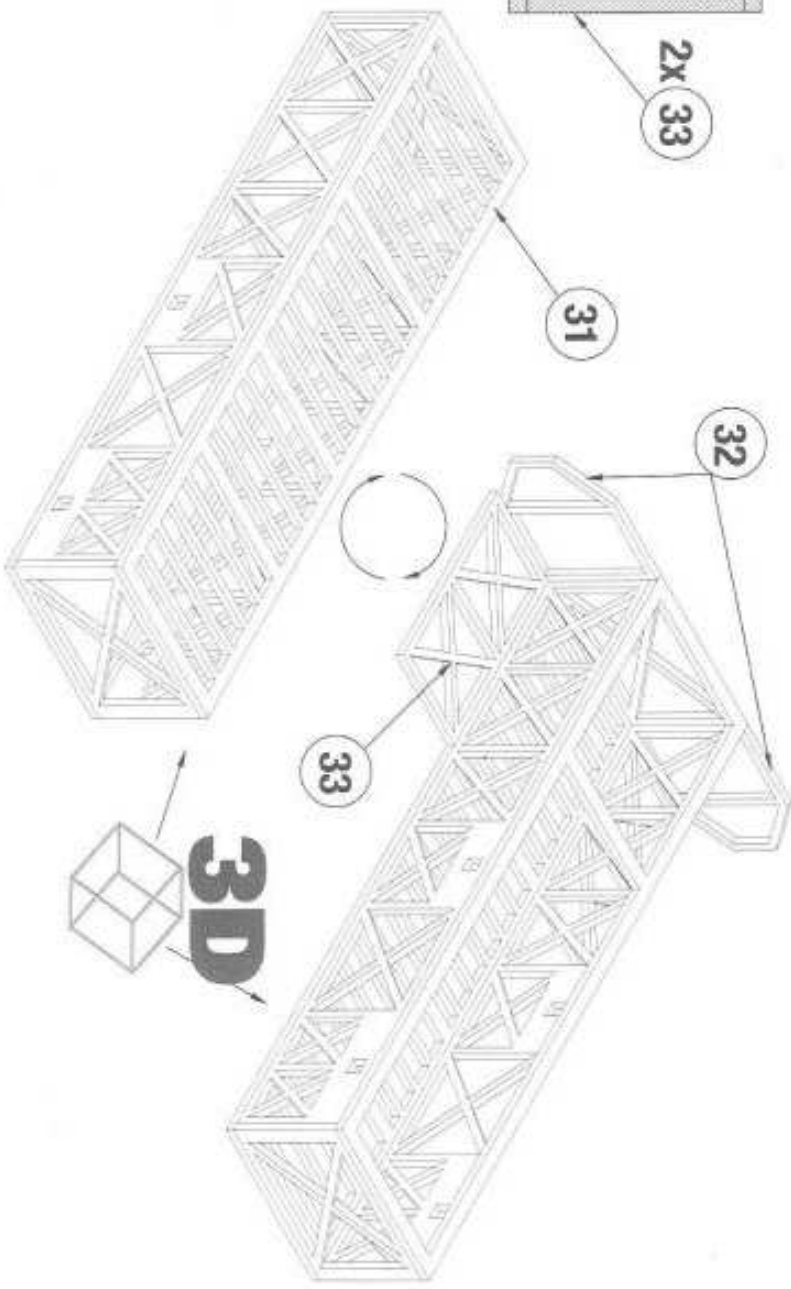
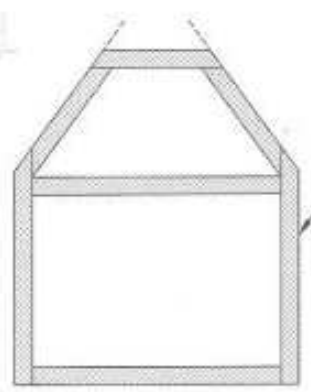
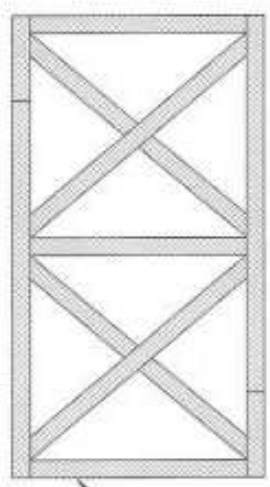
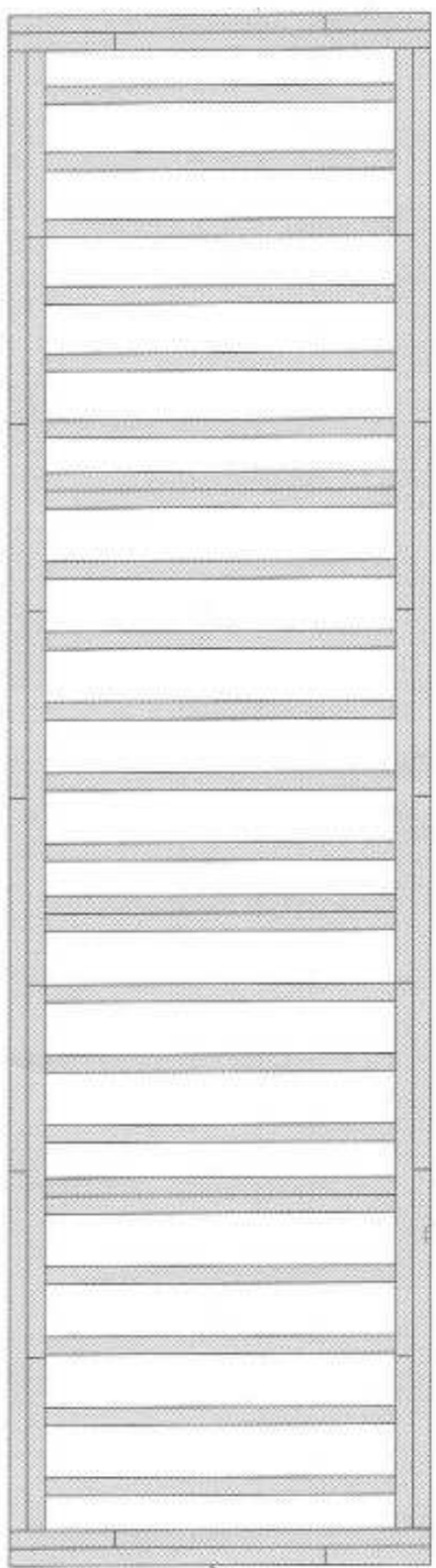

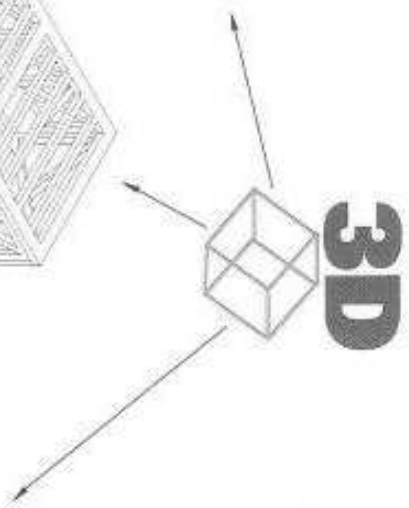
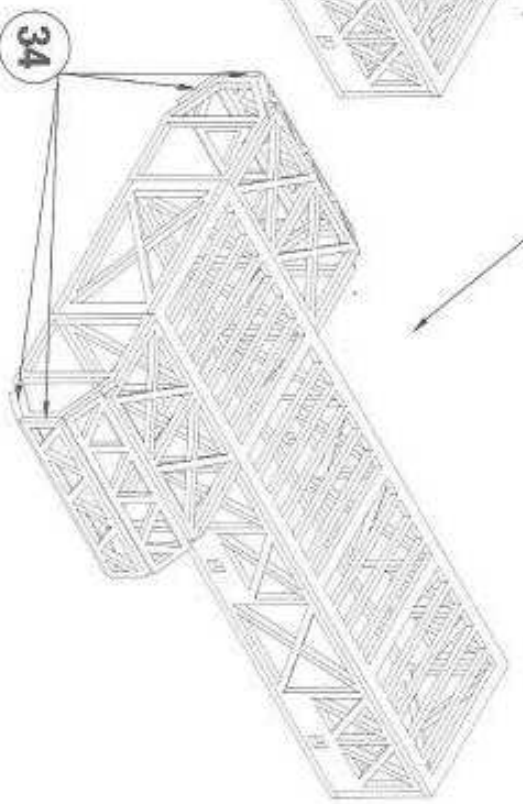
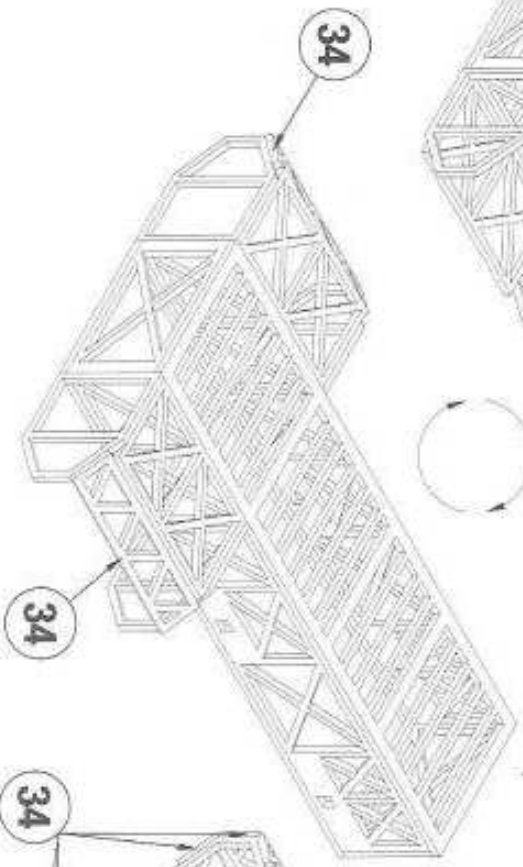
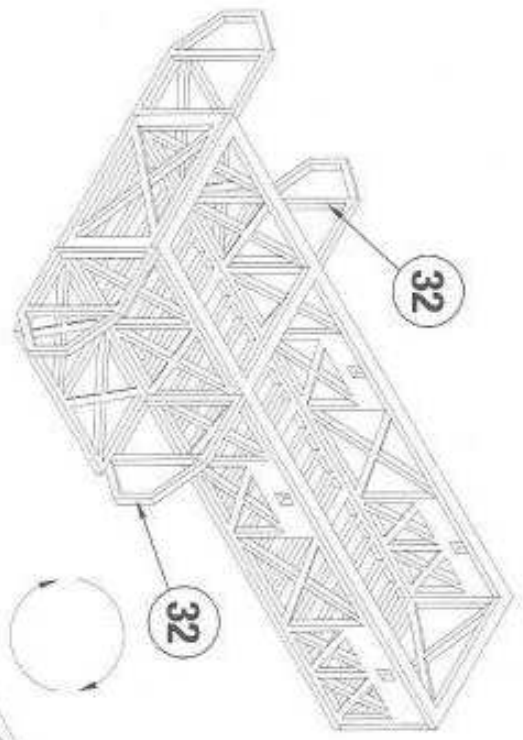
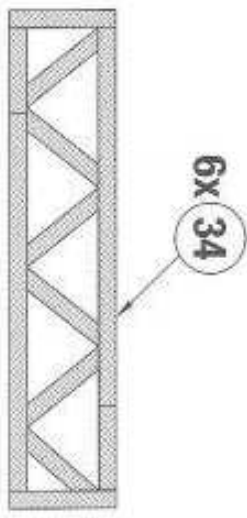

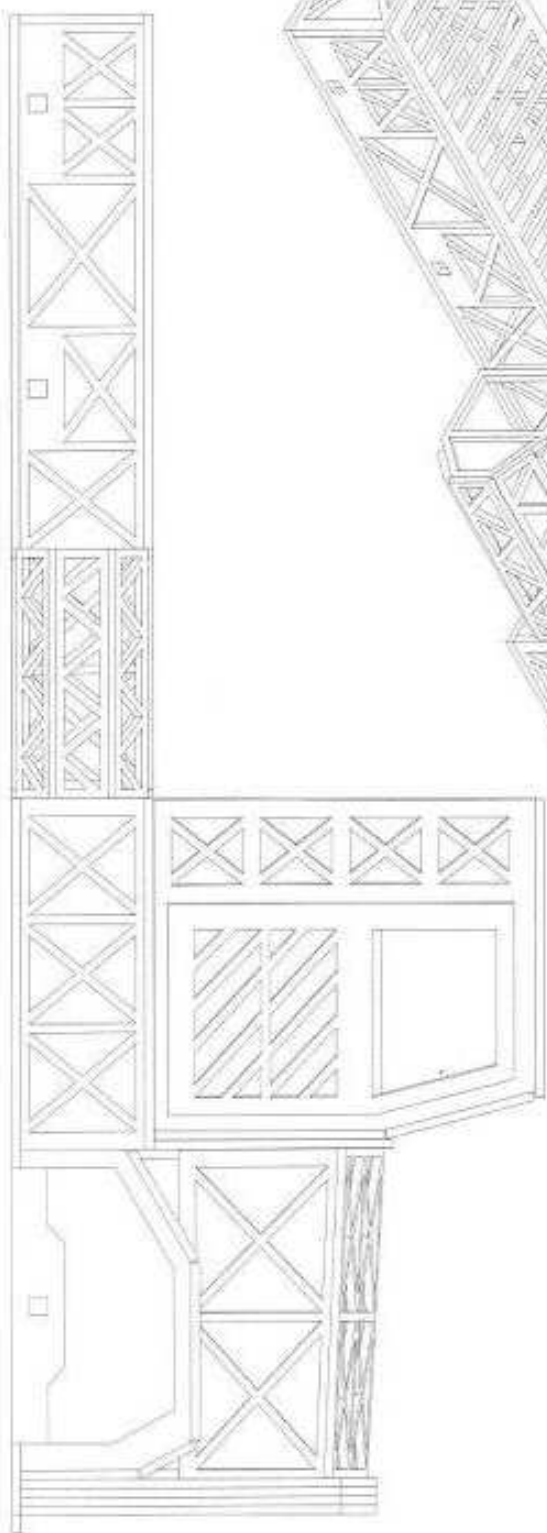
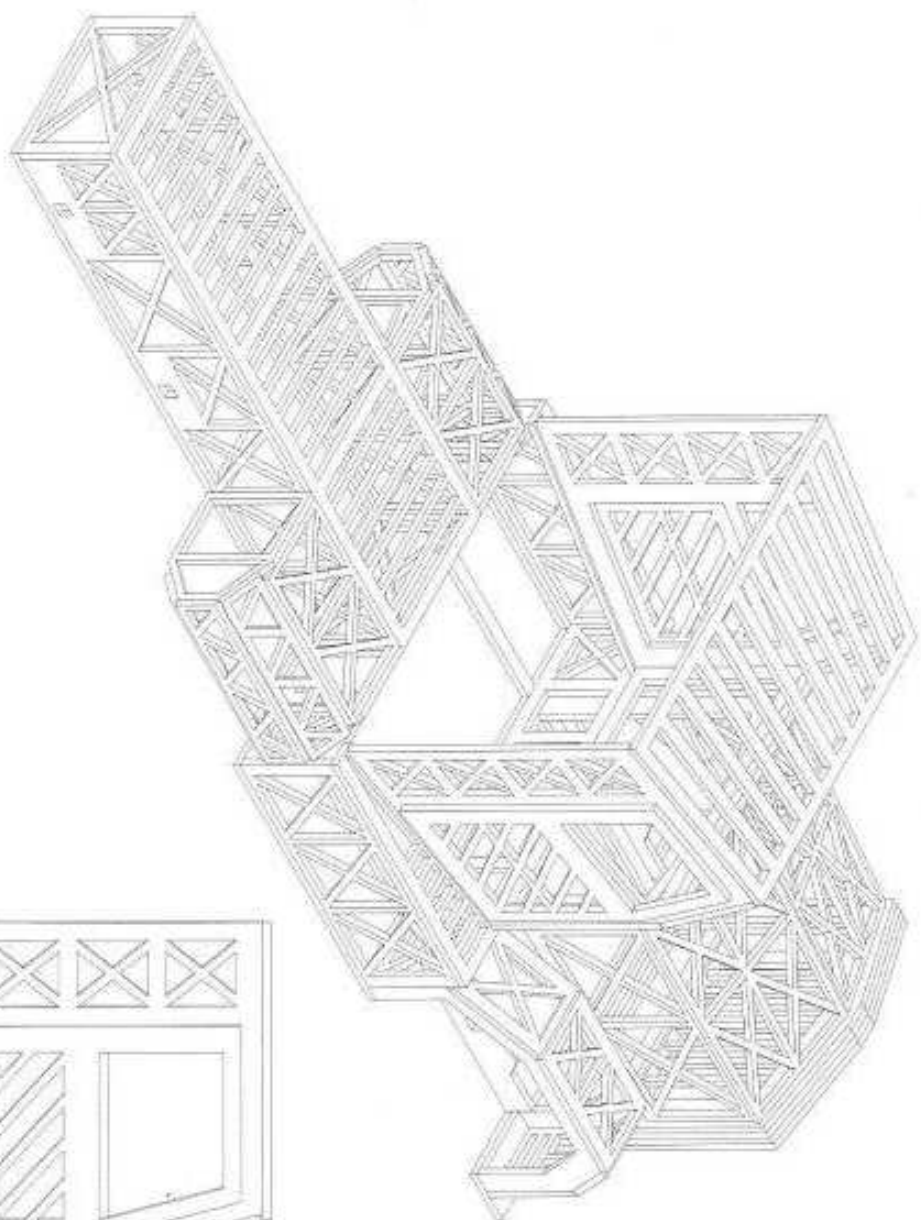

© 2004, Bepco, Inc.

[www.m3architecture.com](http://www.m3architecture.com)

M3ARCHITECTURE

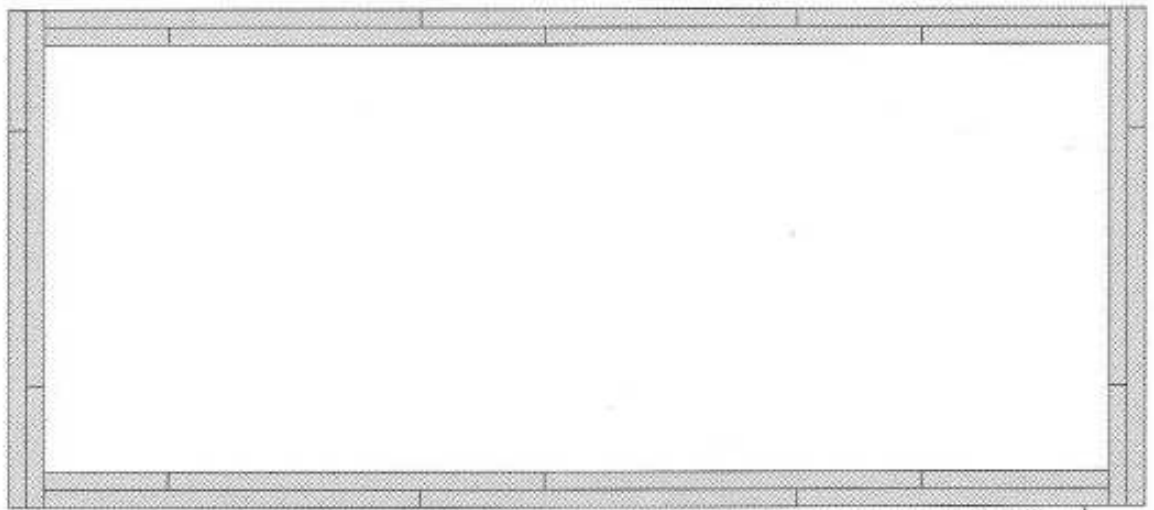

35

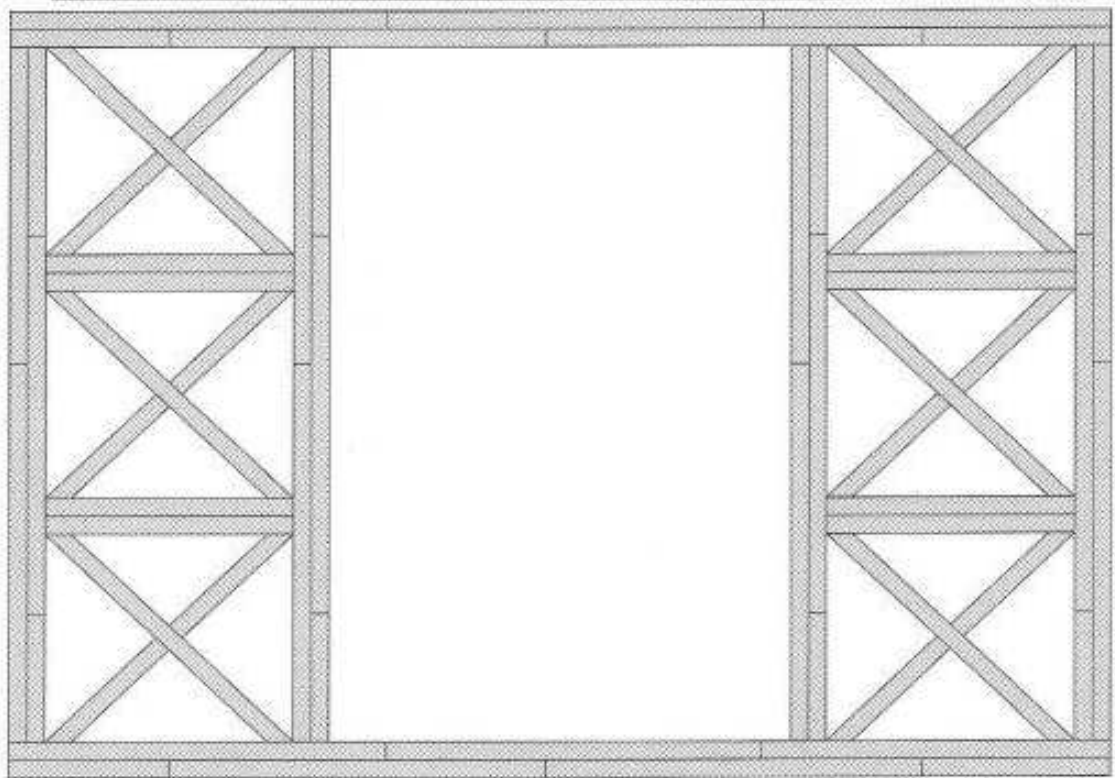

37

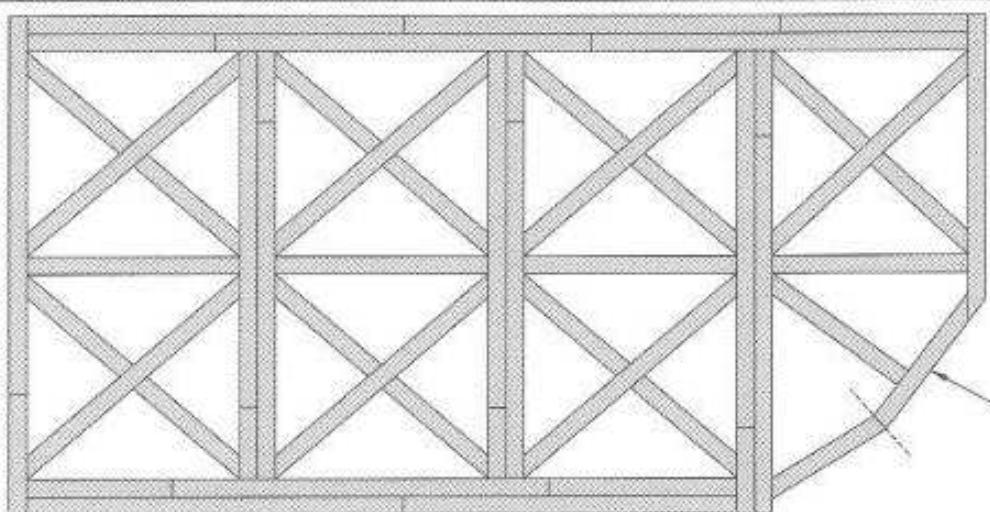

2x 36

38

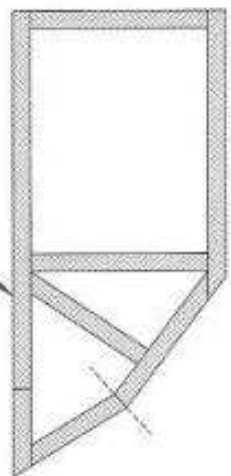
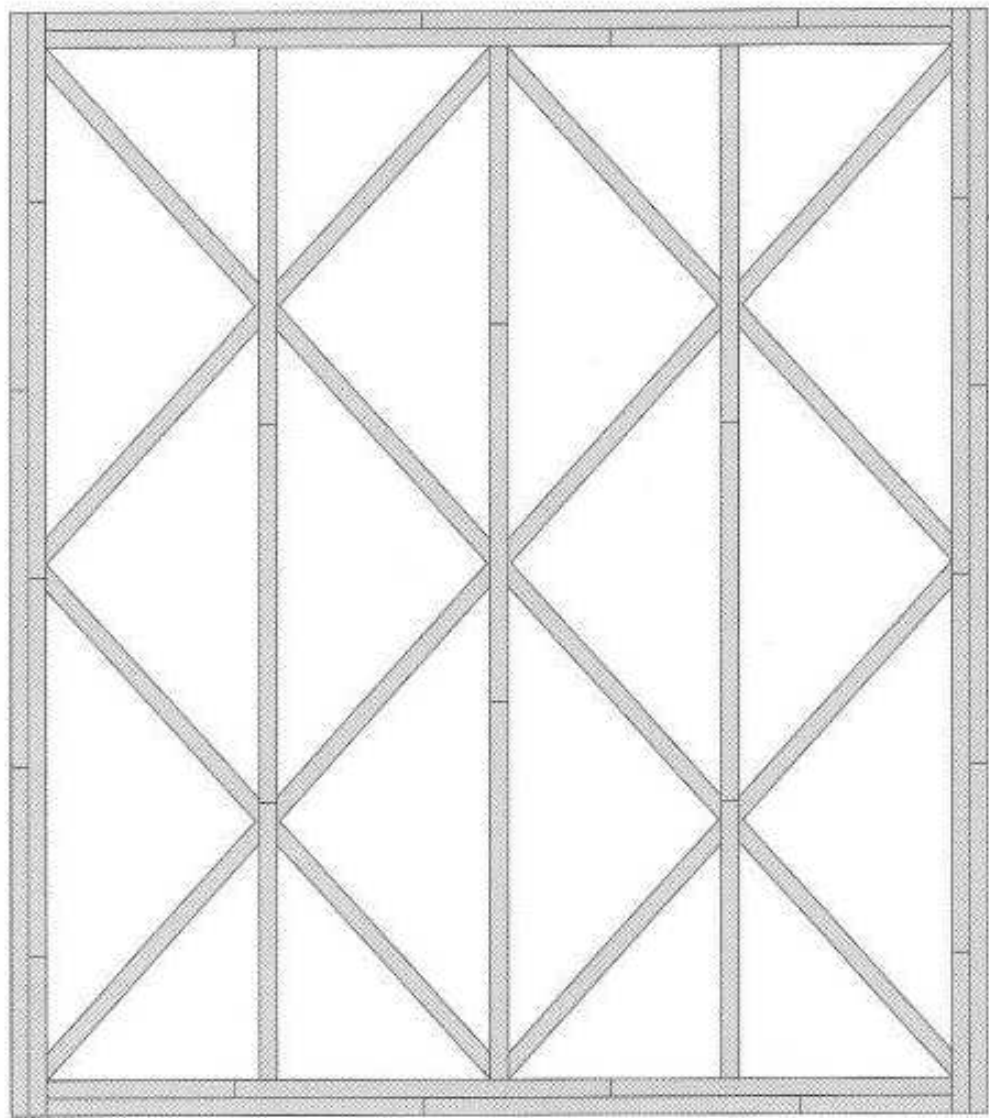

2x 40

2x 39

41

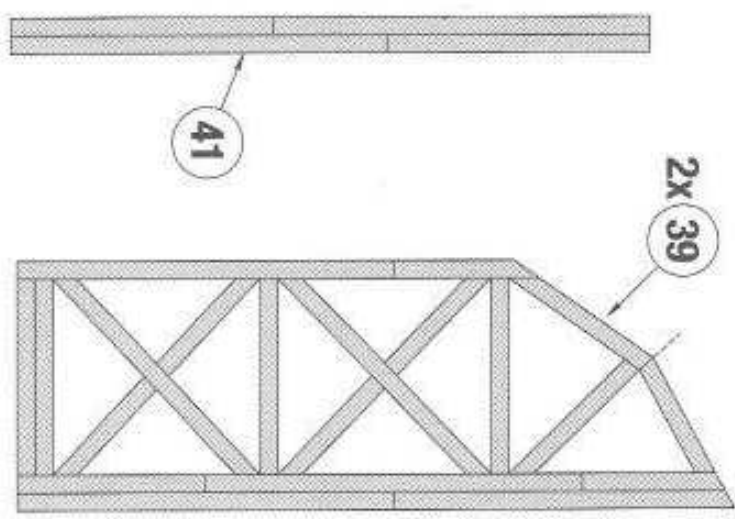

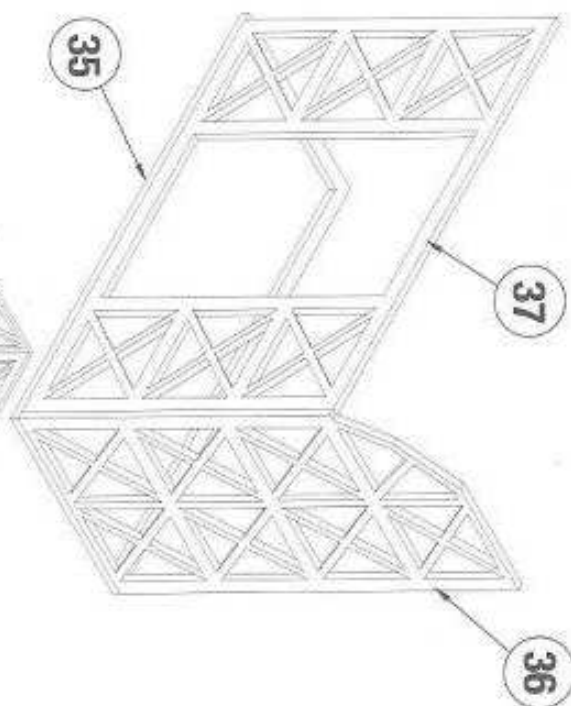
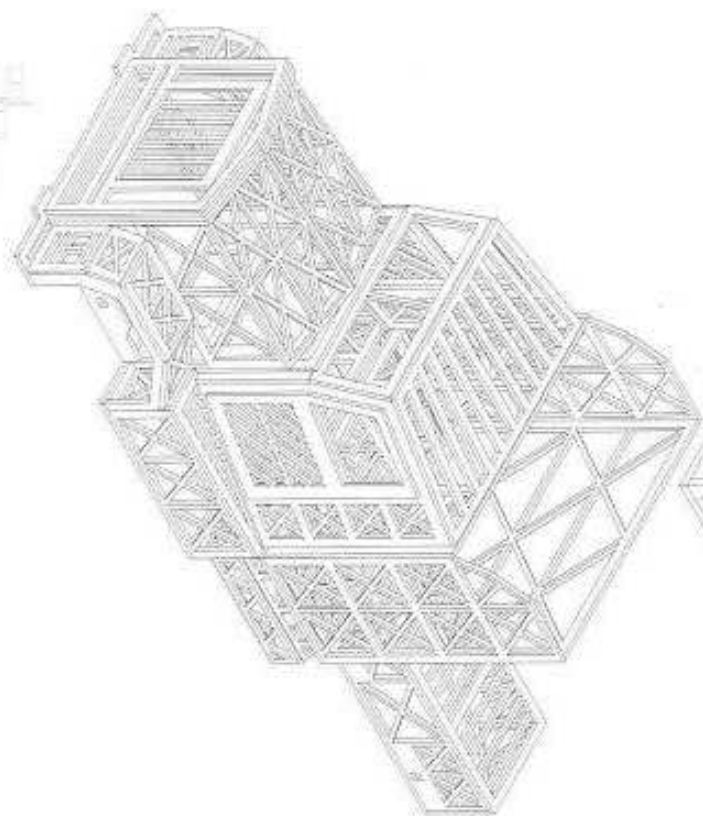

**3D**

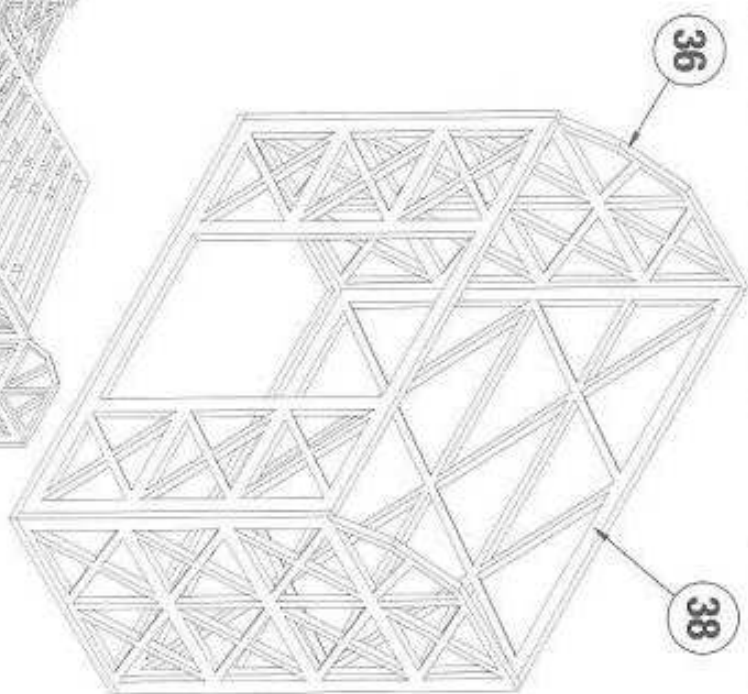
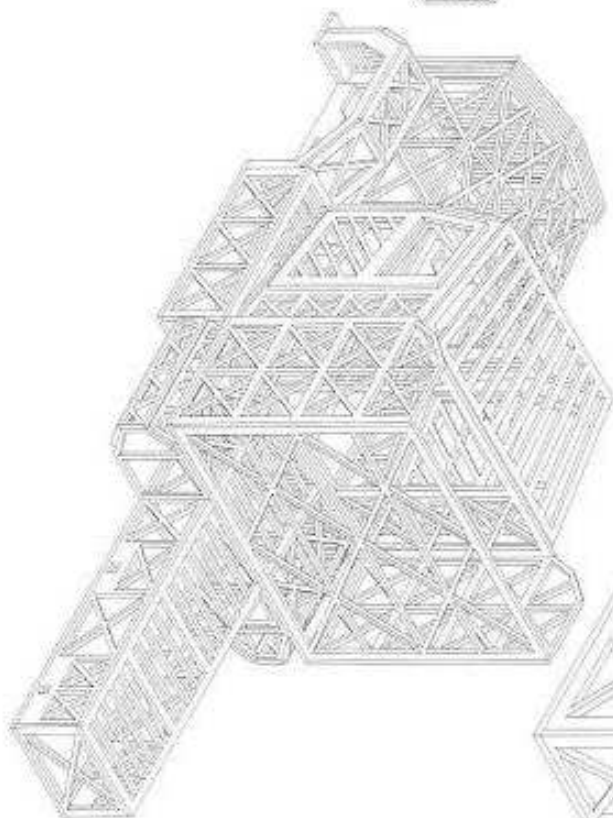

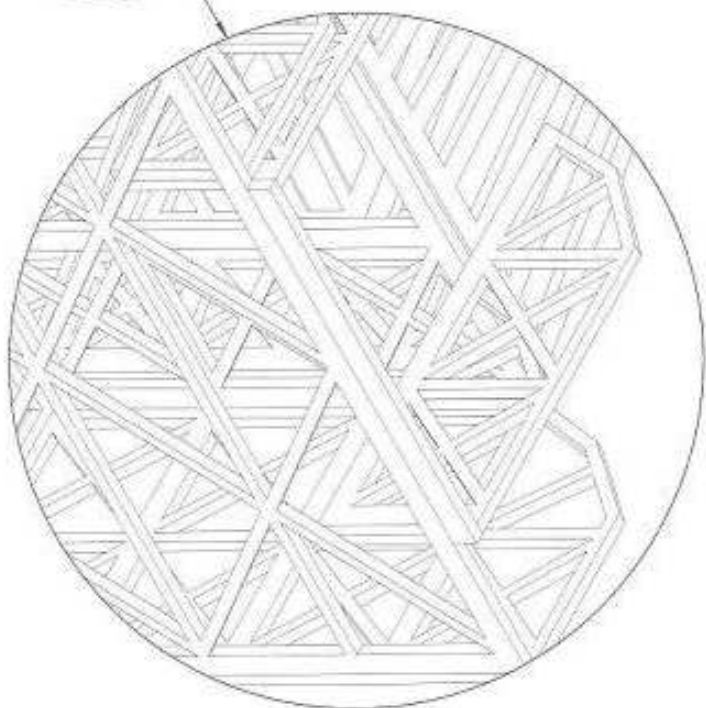
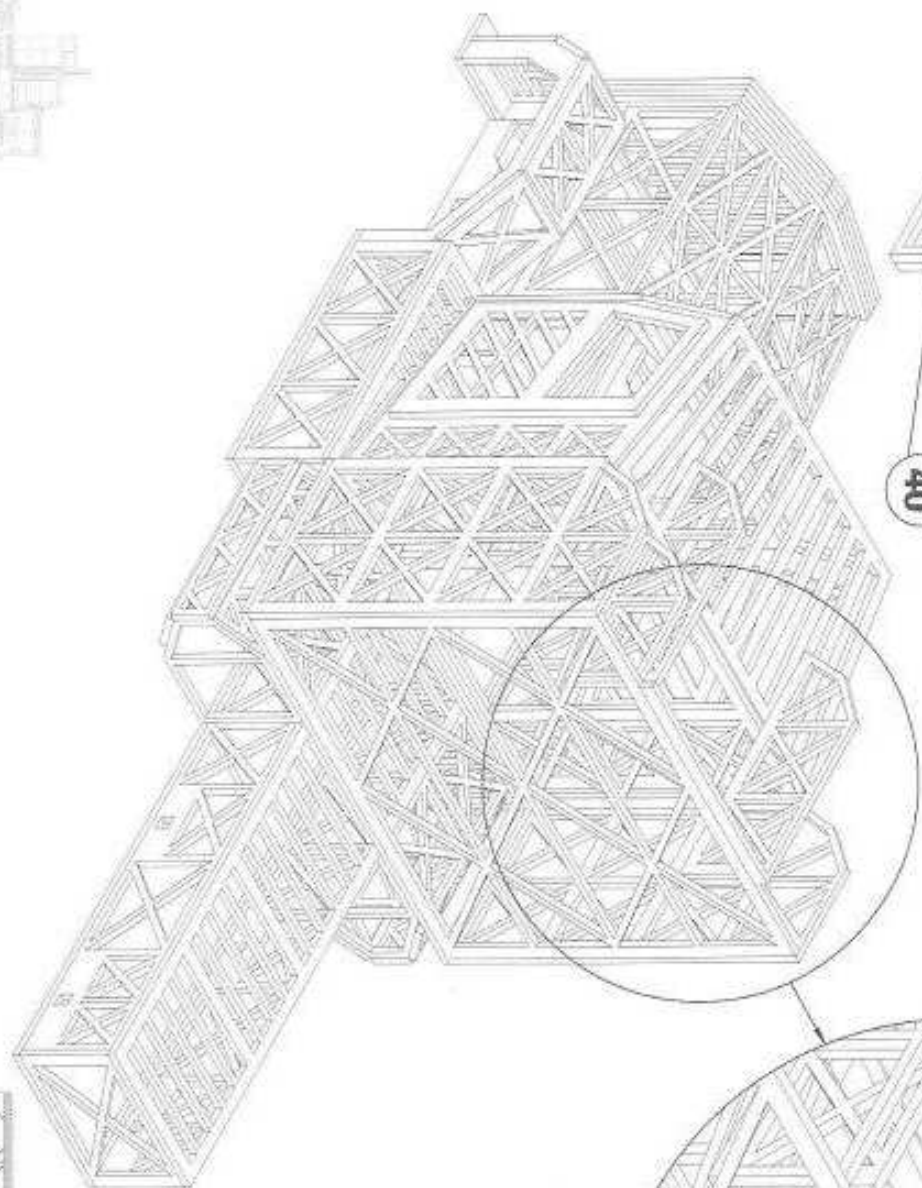
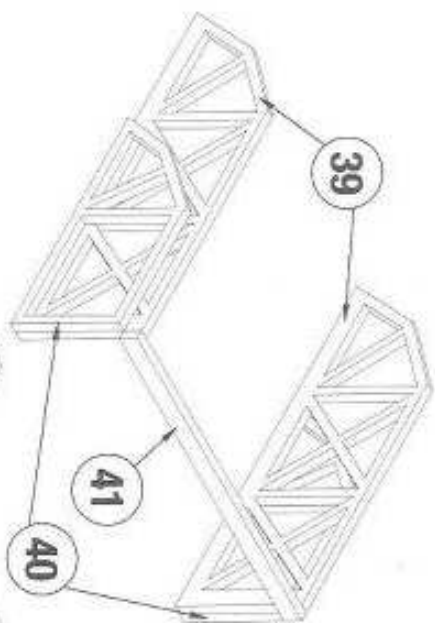

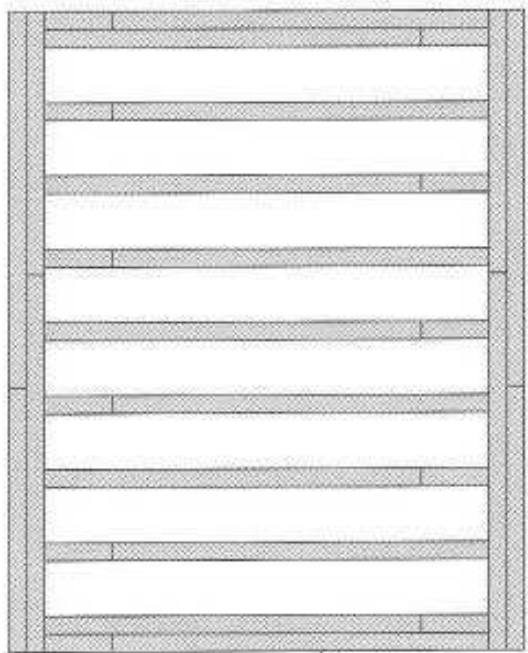

42

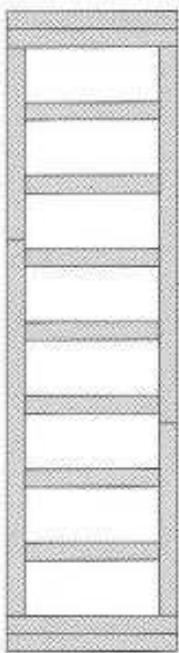

2x 43

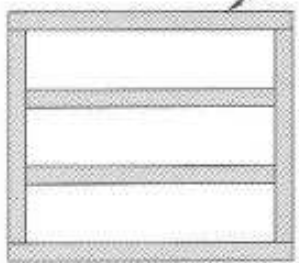

2x 44

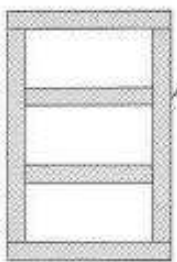

2x 45

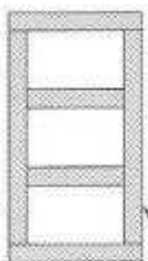

2x 46



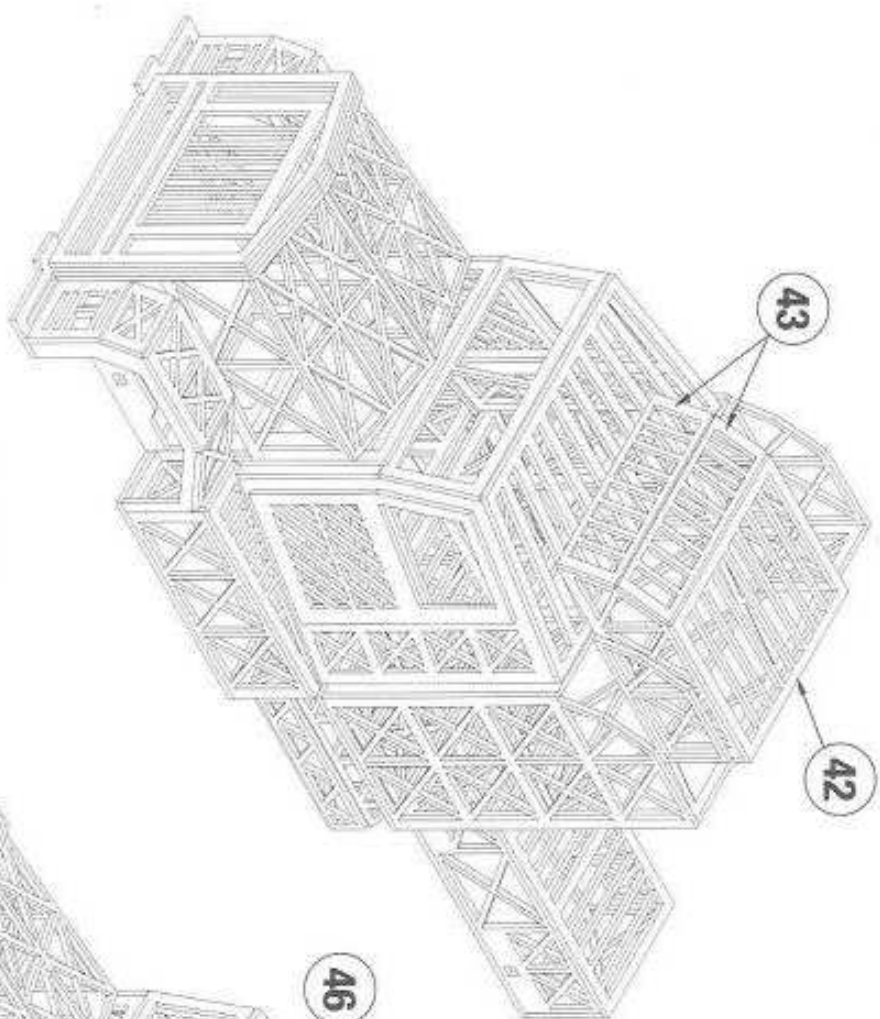

43

42

**3D**

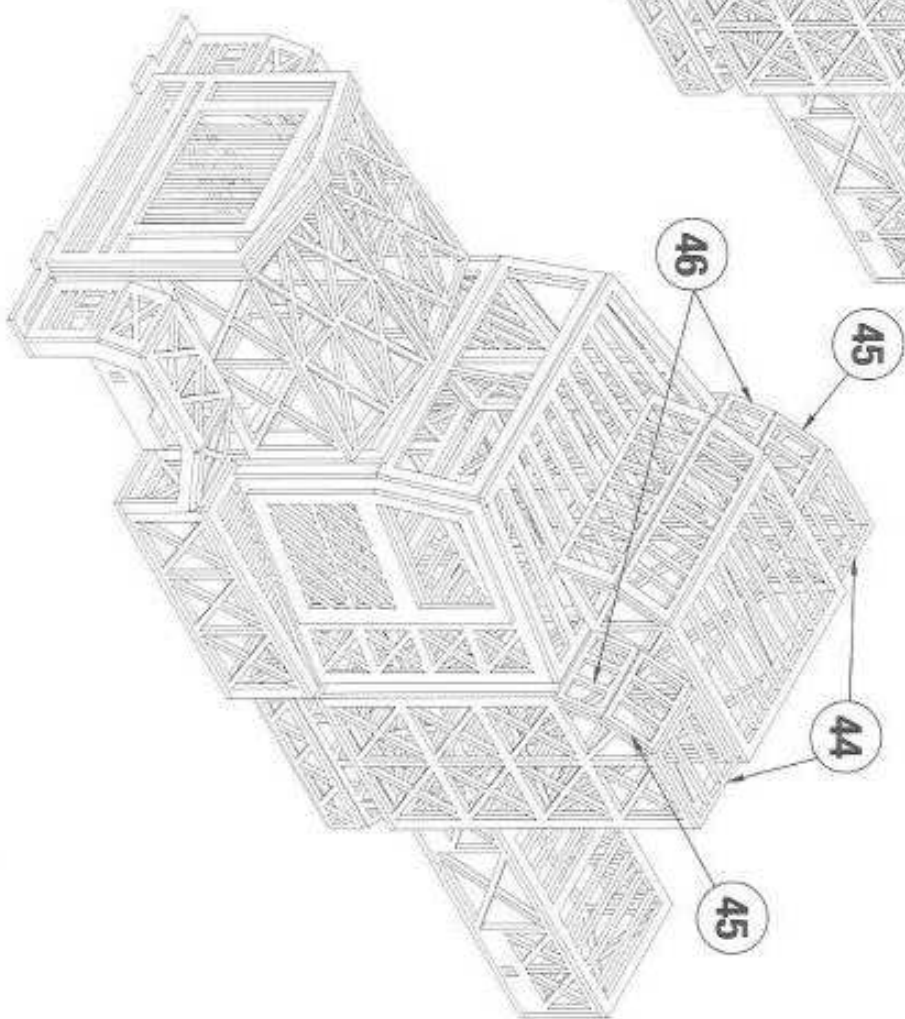

45

46

44

45

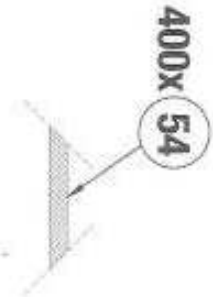
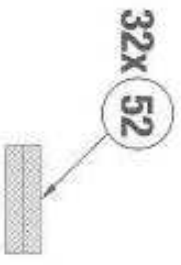
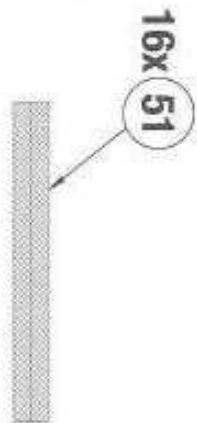
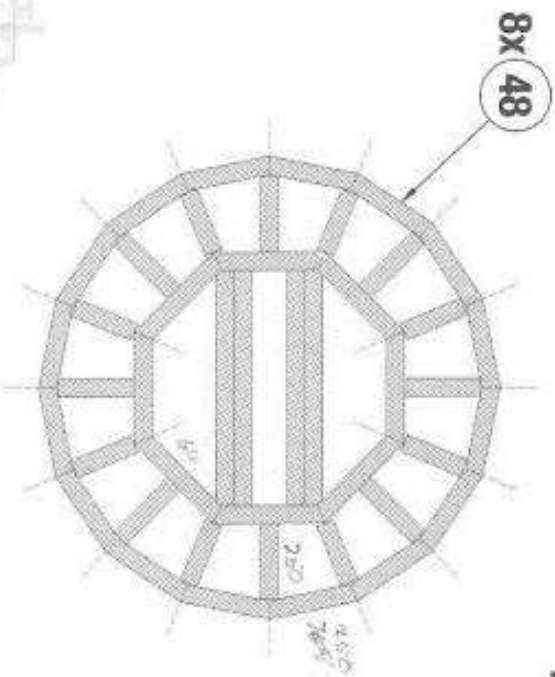
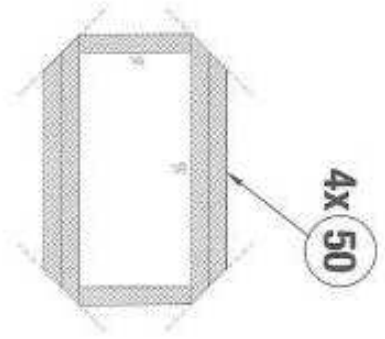
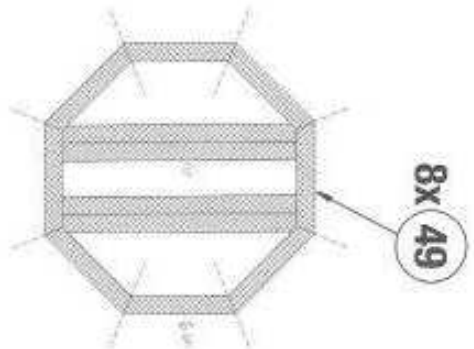
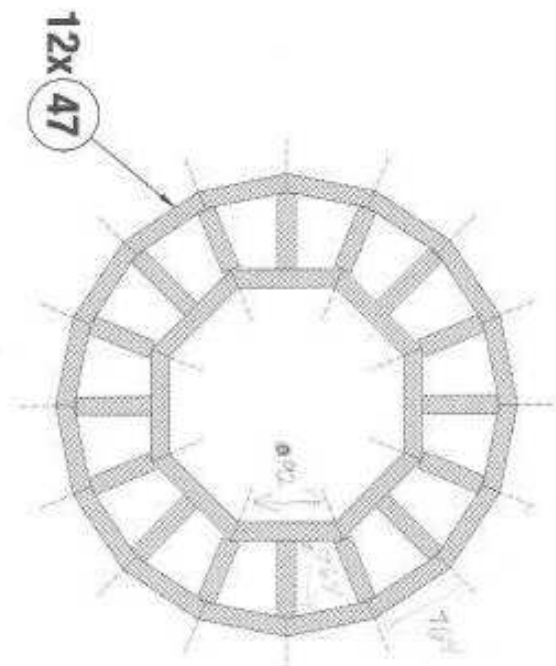

© 2004 Blyden, Inc.

www.matchitecture.com



x4

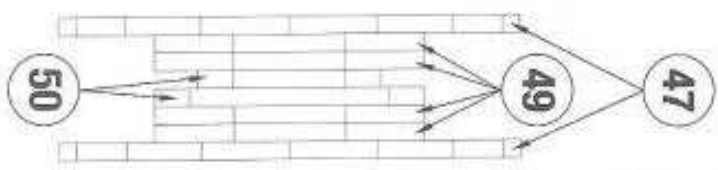
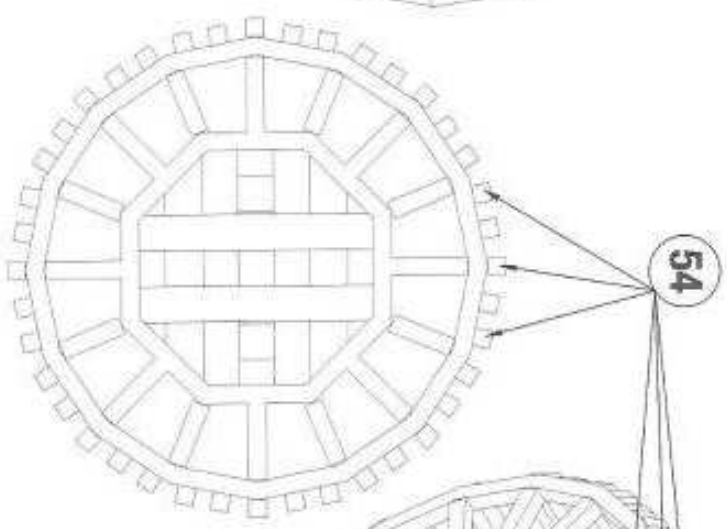
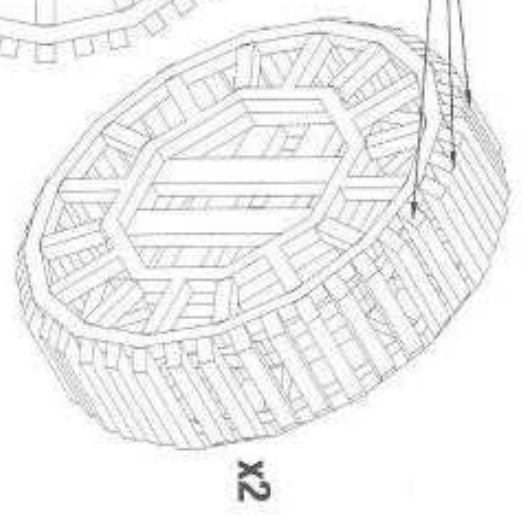
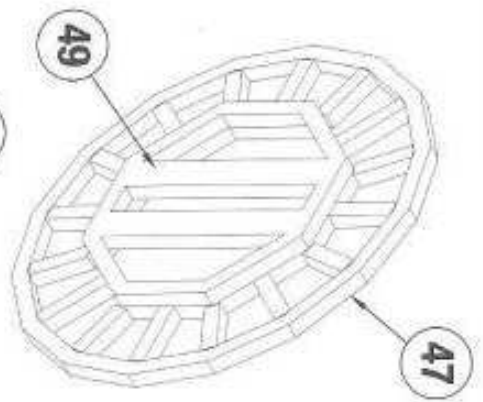
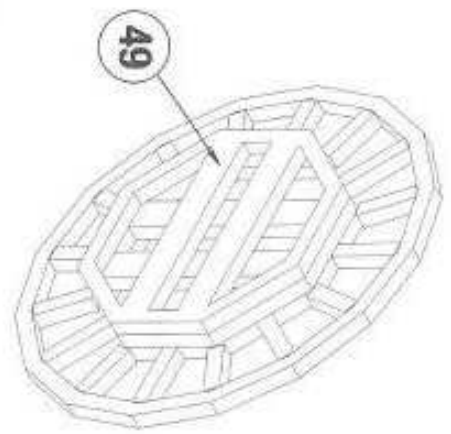
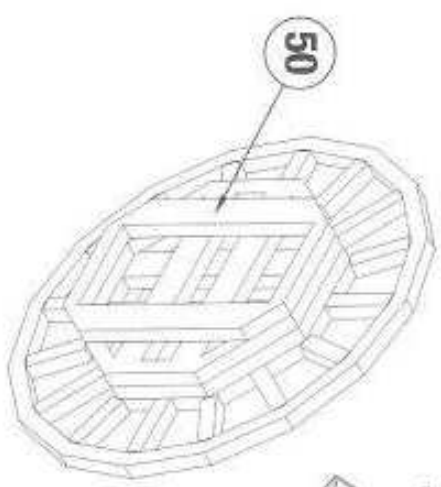

© 2004 Brown, Inc.

www.matchitecture.com

MATCHITECTURE

25 JAN



2x 55

55

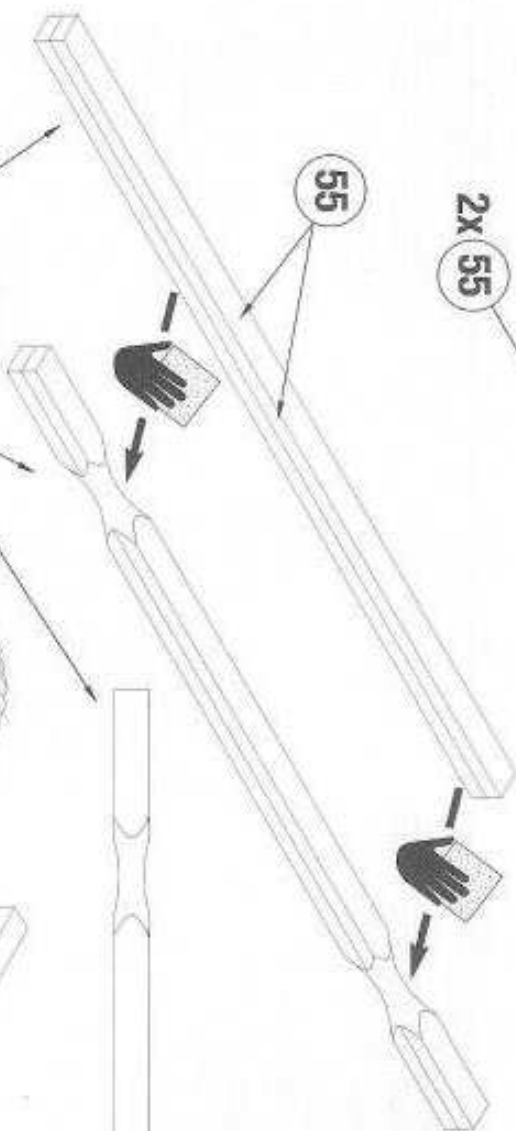

3D

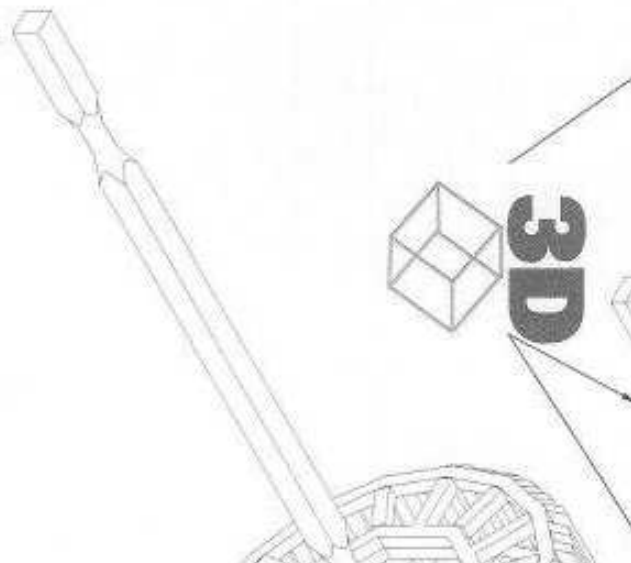

3D

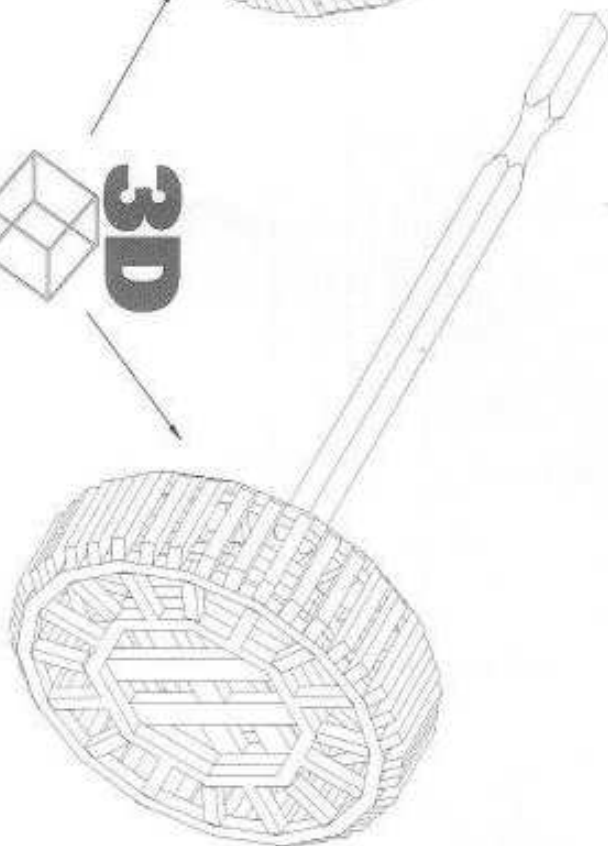

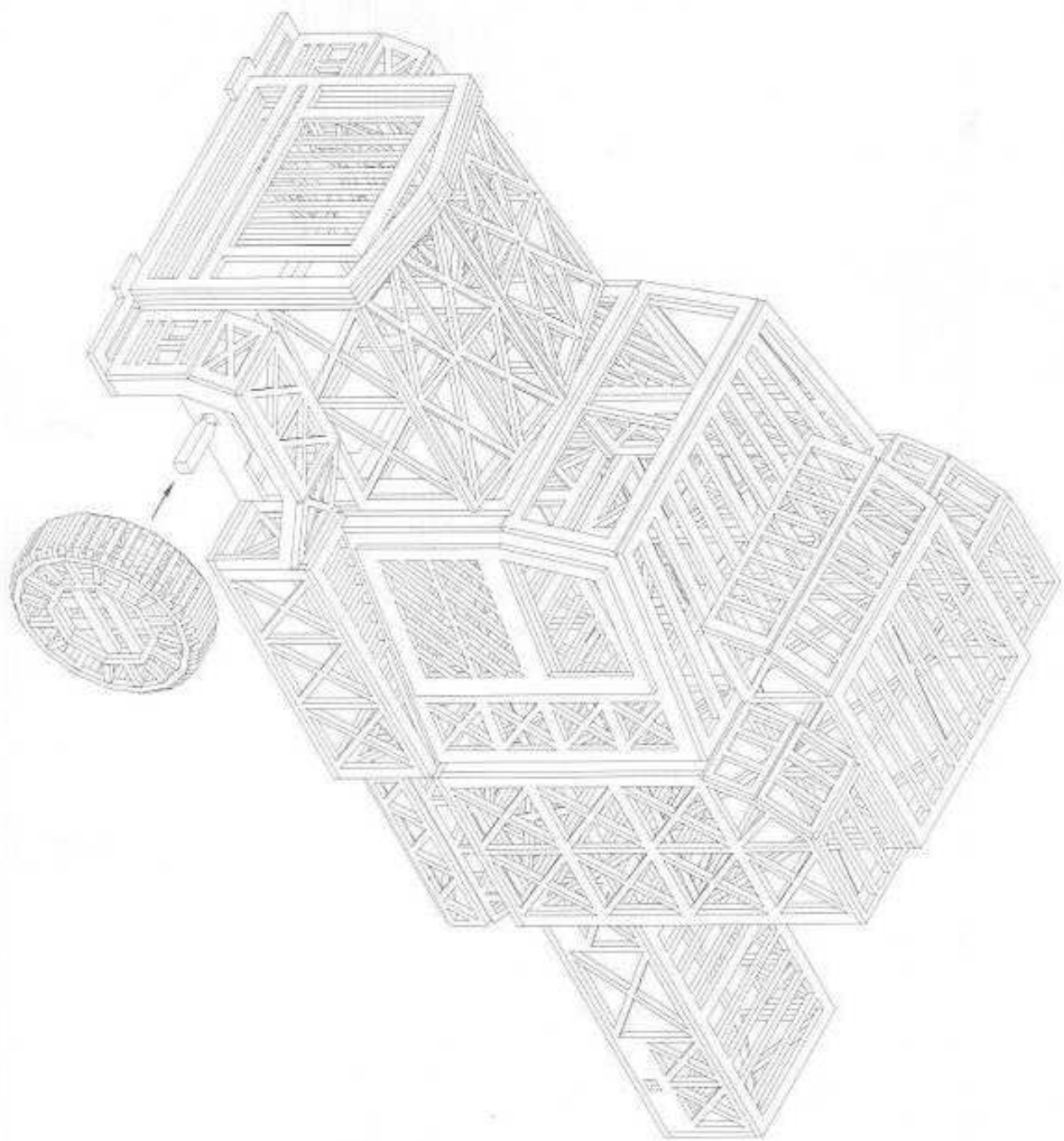

© 2004 Sigurd Hvi



[www.matchitecture.com](http://www.matchitecture.com)



**MATCHITECTURE**



**27** / 44

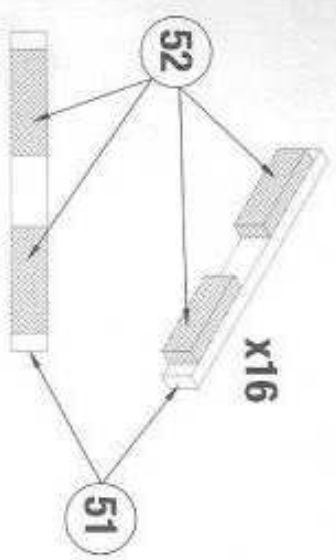

# 3D

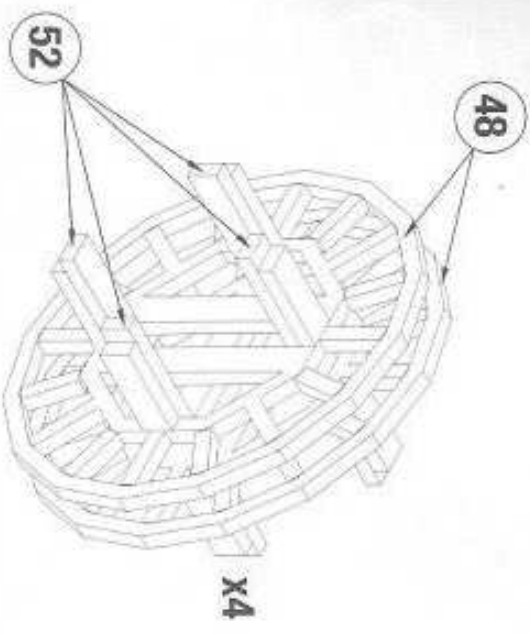
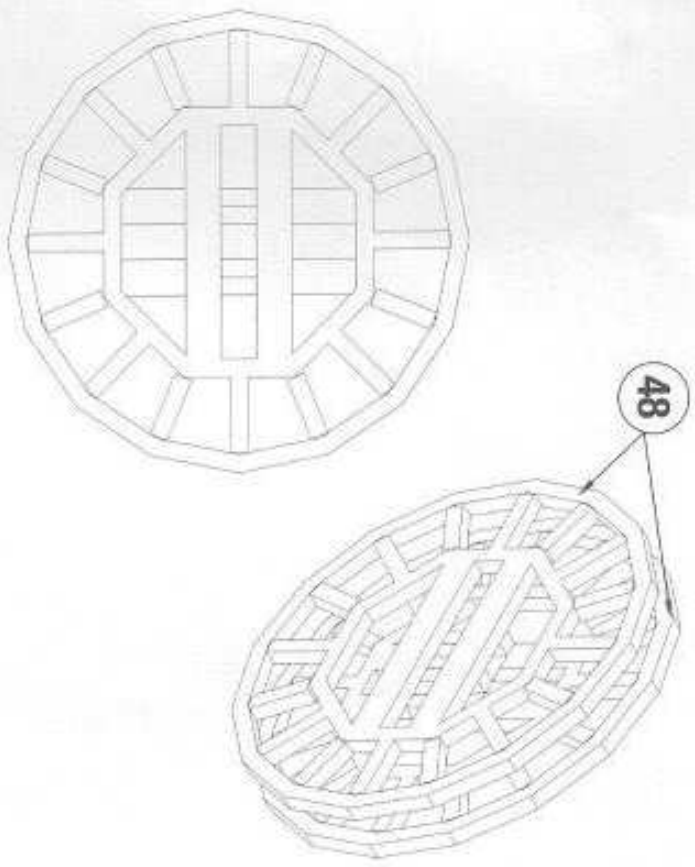
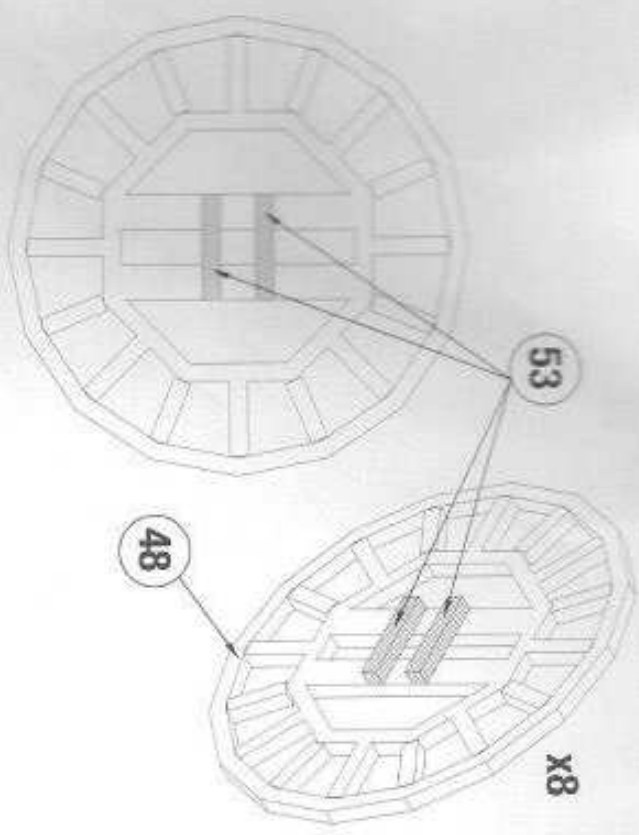

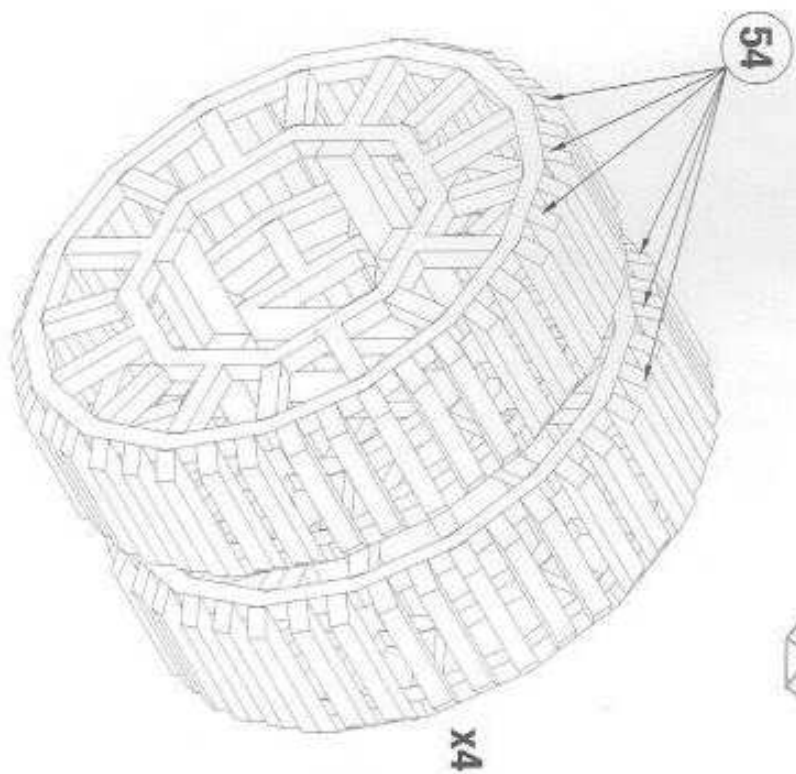
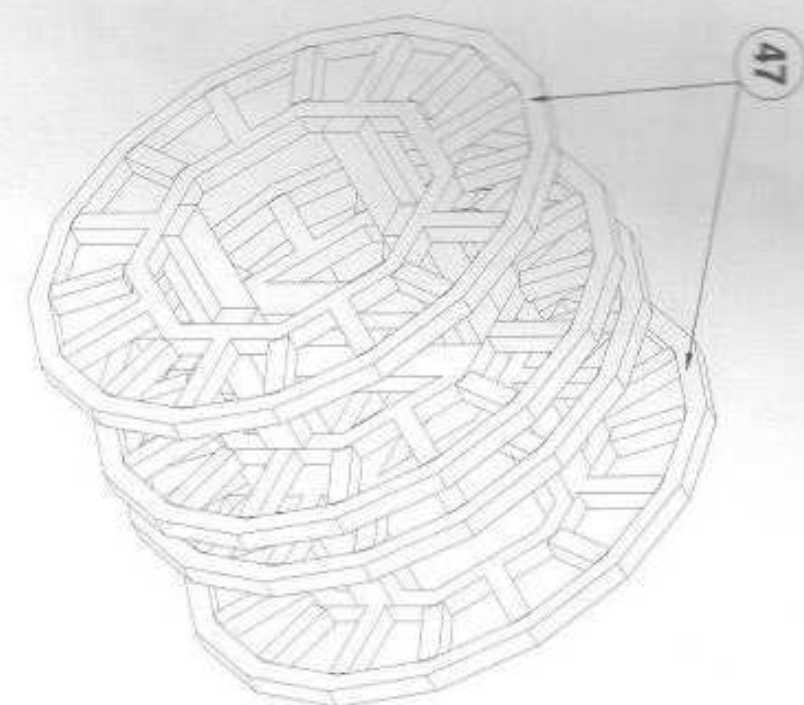

© 2004 Lewis & Clark

[www.matchitecture.com](http://www.matchitecture.com)



4x 56

56

x2

**3D**



47

**3D**



x2

53

48

56

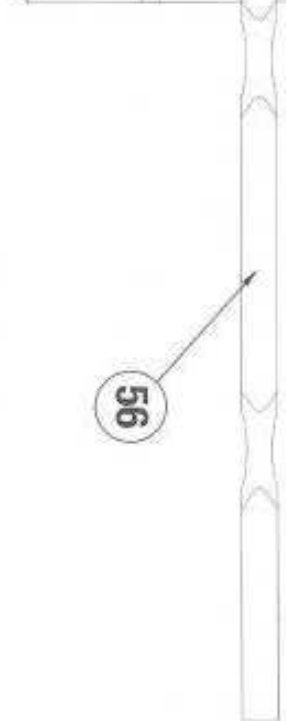
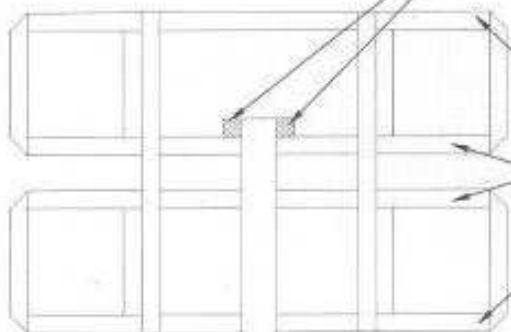
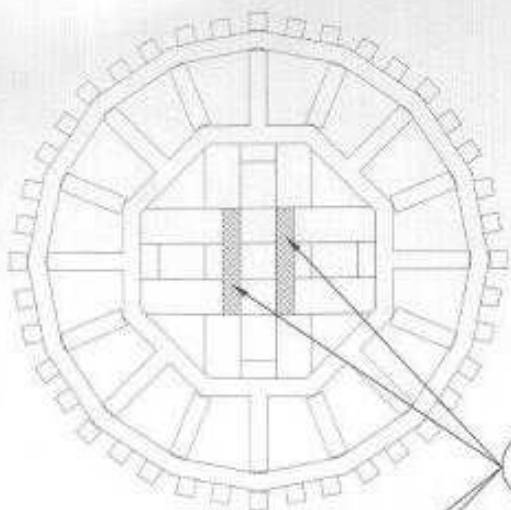

**3D**

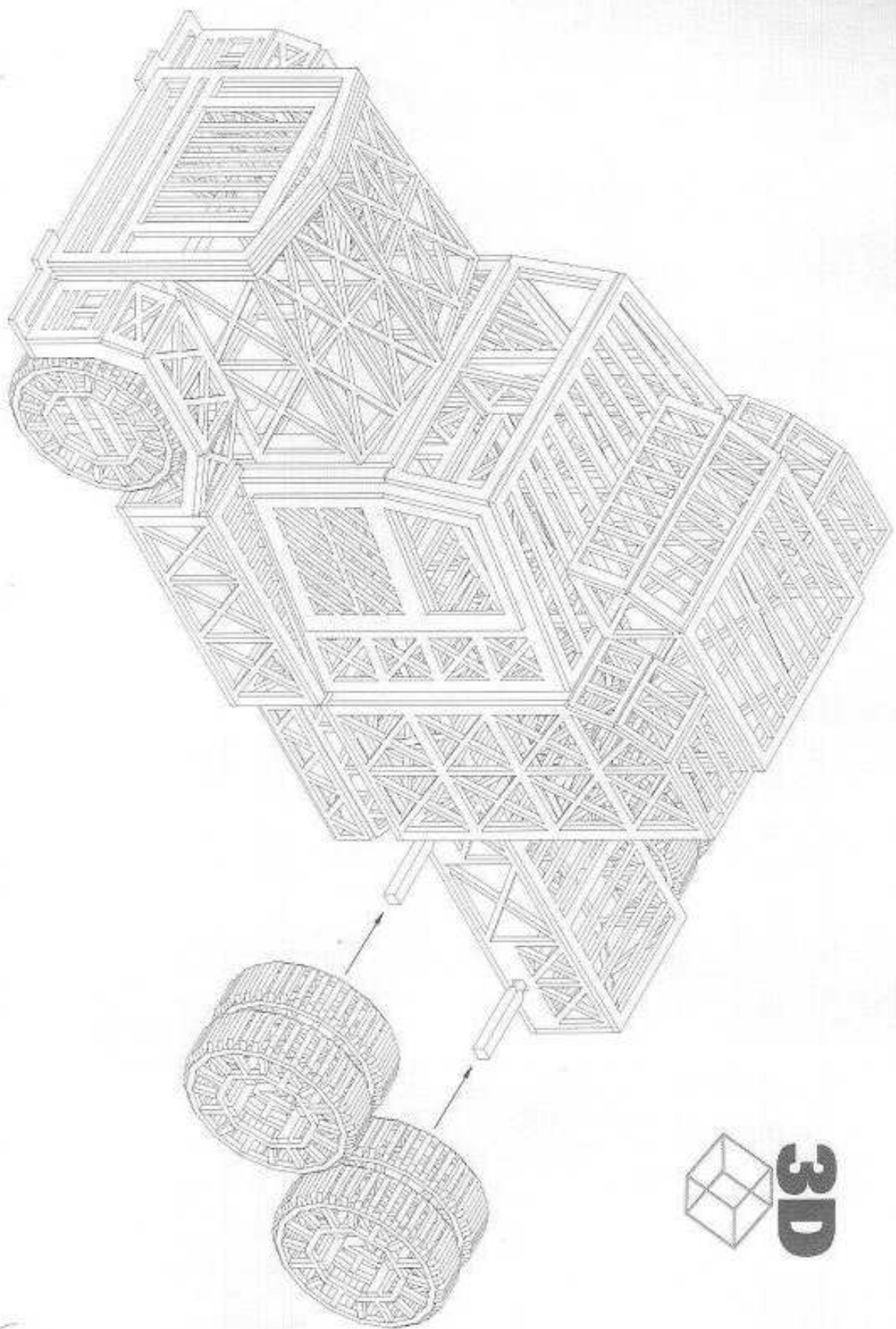

© 2004 Berman Inc.

[www.matechitecture.com](http://www.matechitecture.com)

MATECHITECTURE

31 / 41

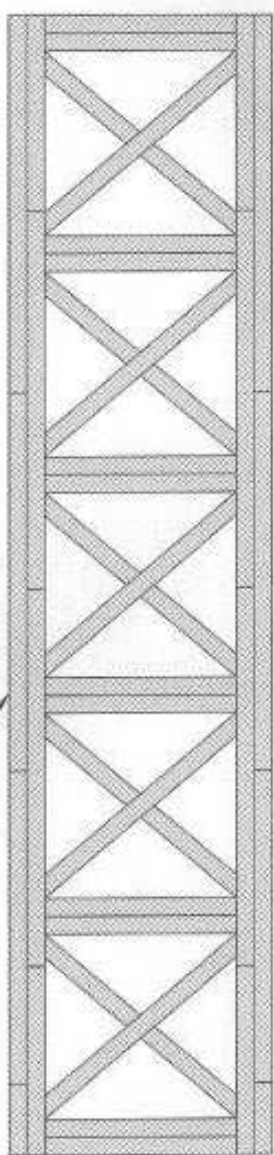

58

57

4x 59



2x 61

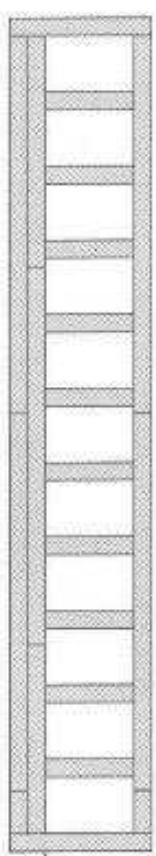
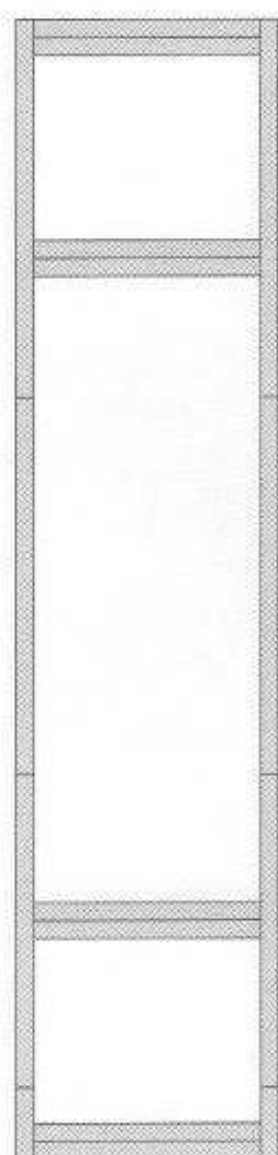
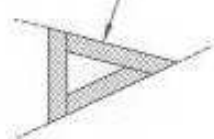

60



© 2004 B&B, Inc.

www.mitchitecture.com

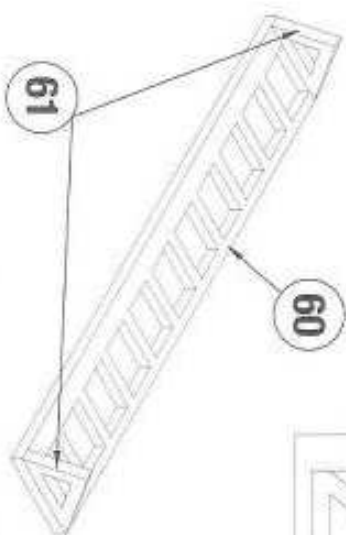
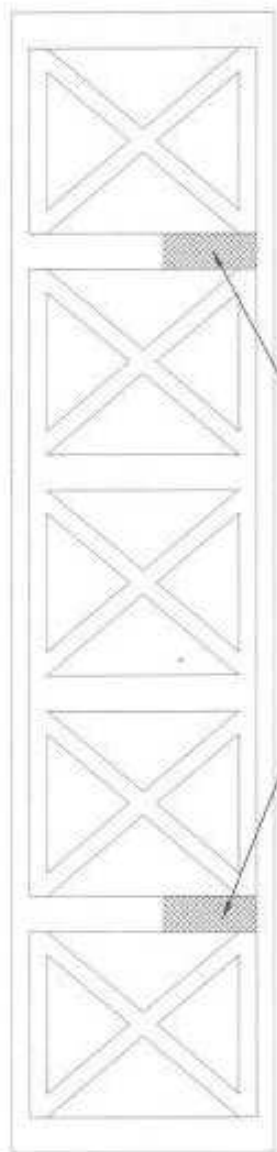
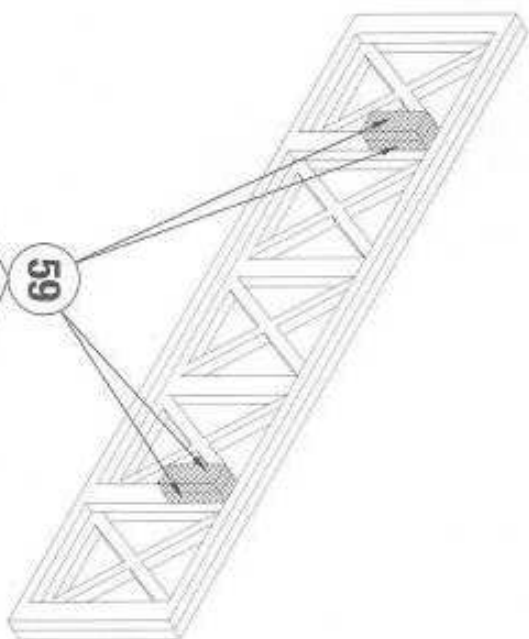
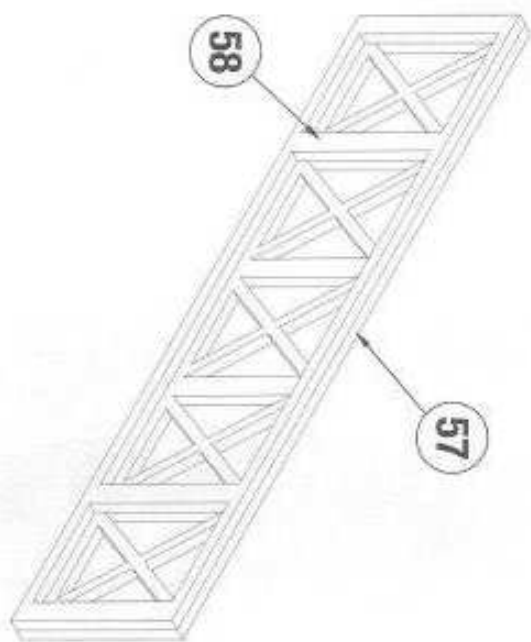

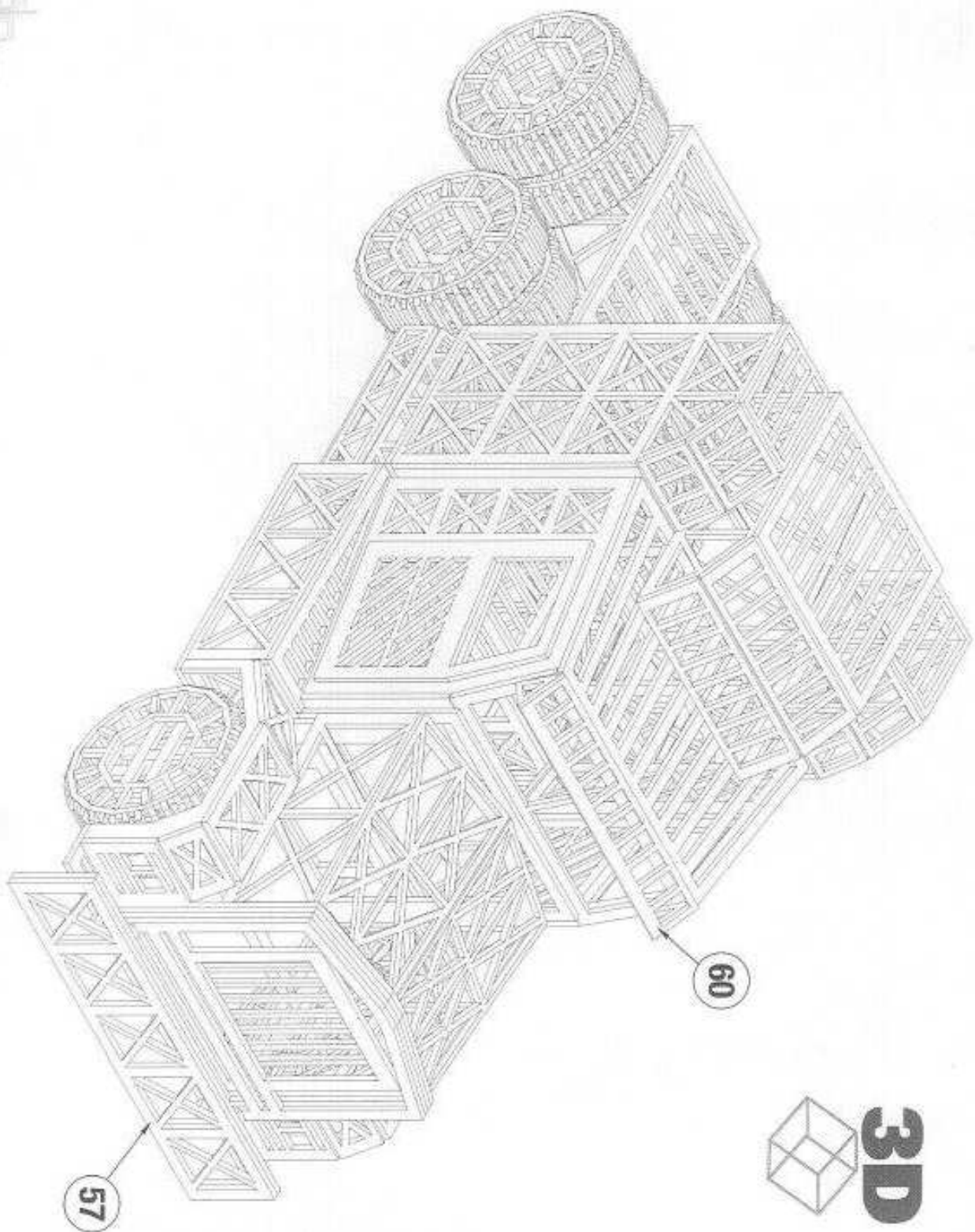

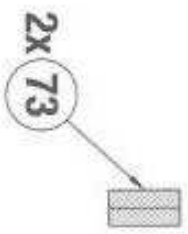
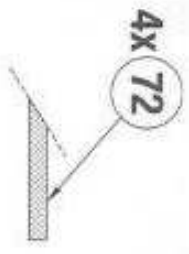
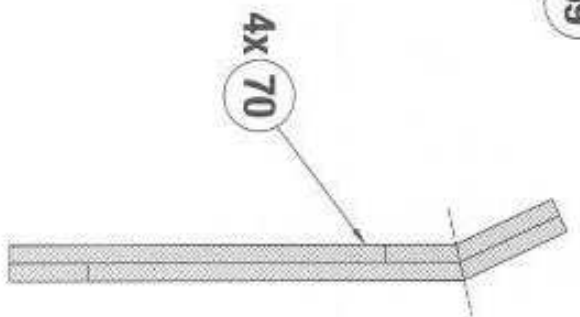
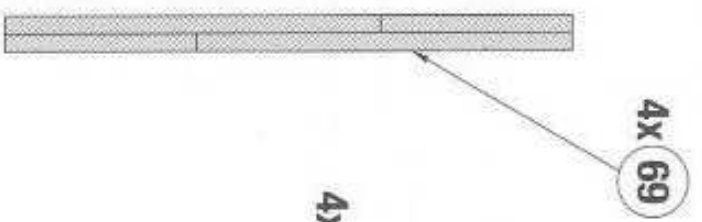
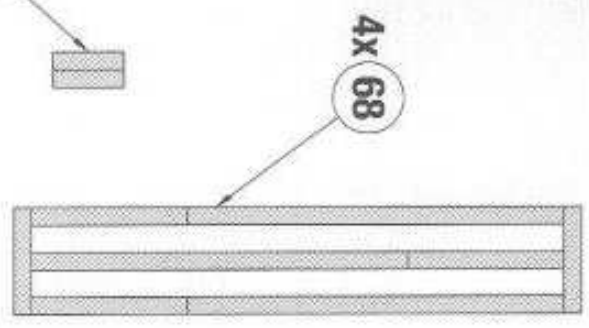
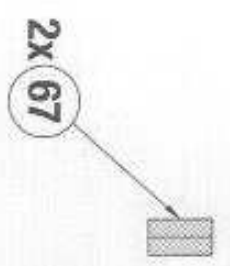
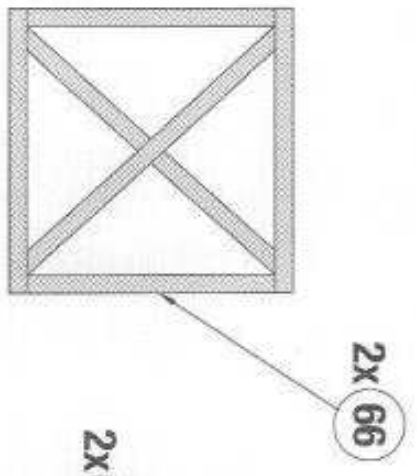
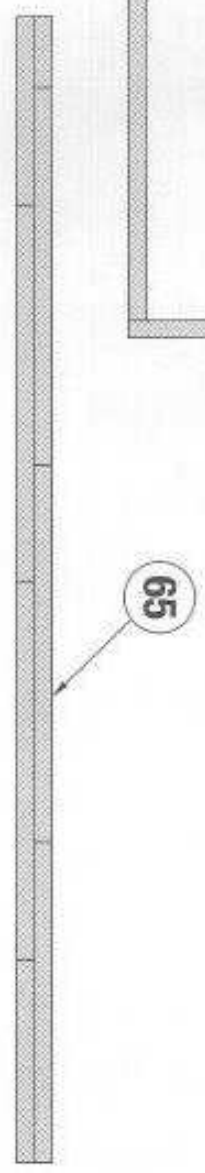
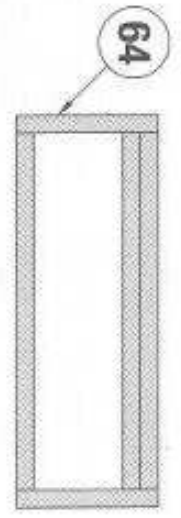
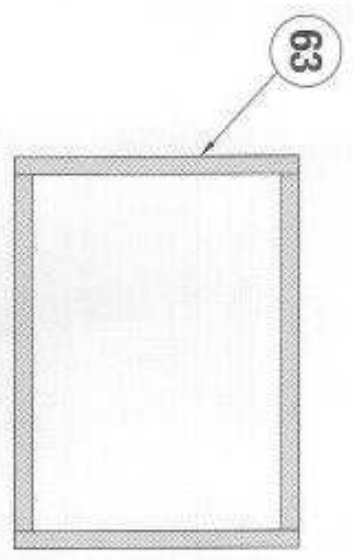
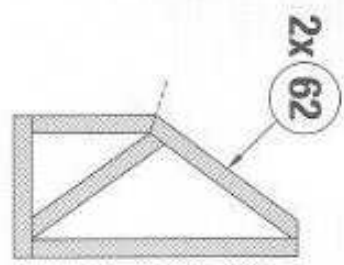

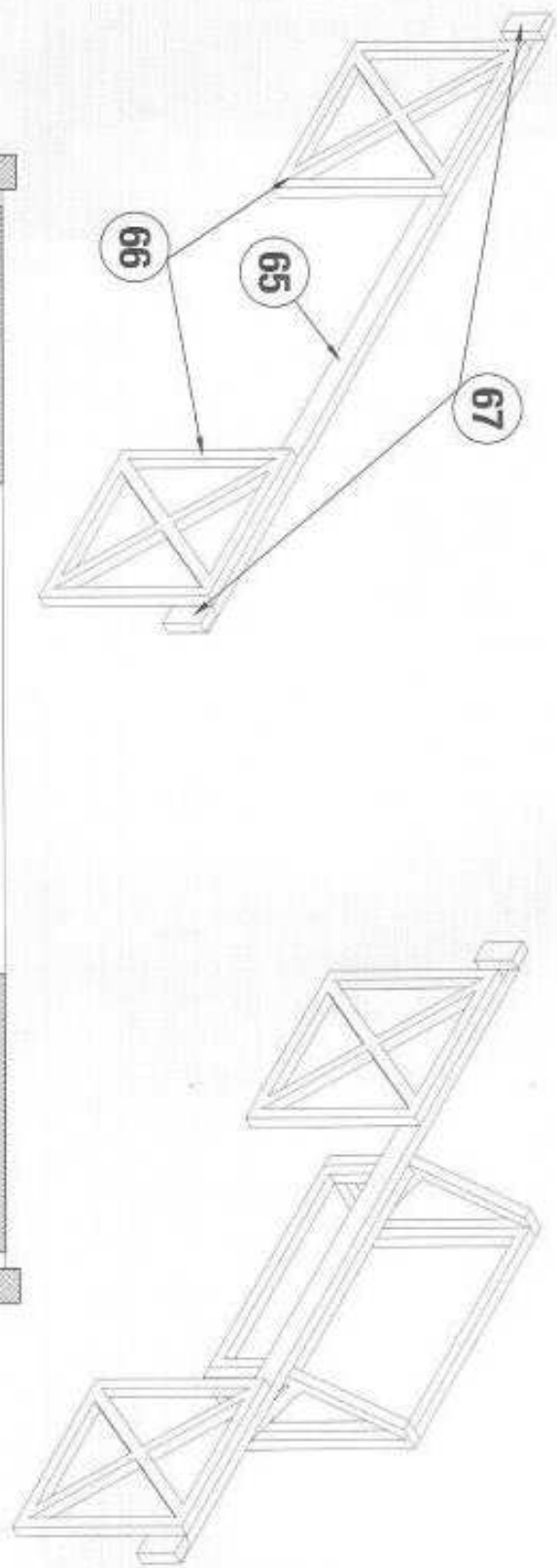
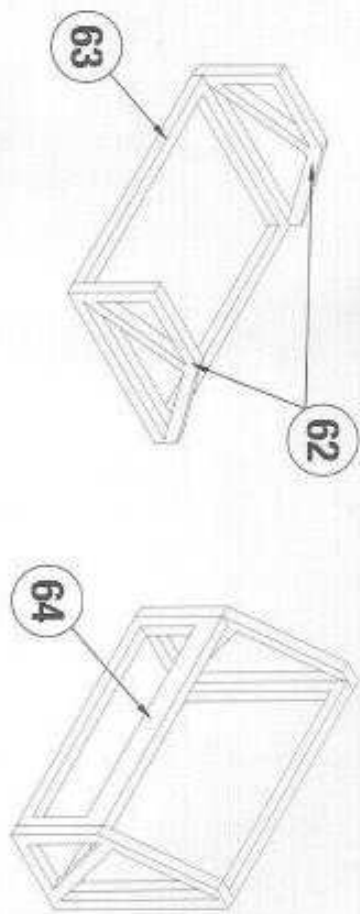

**3D**

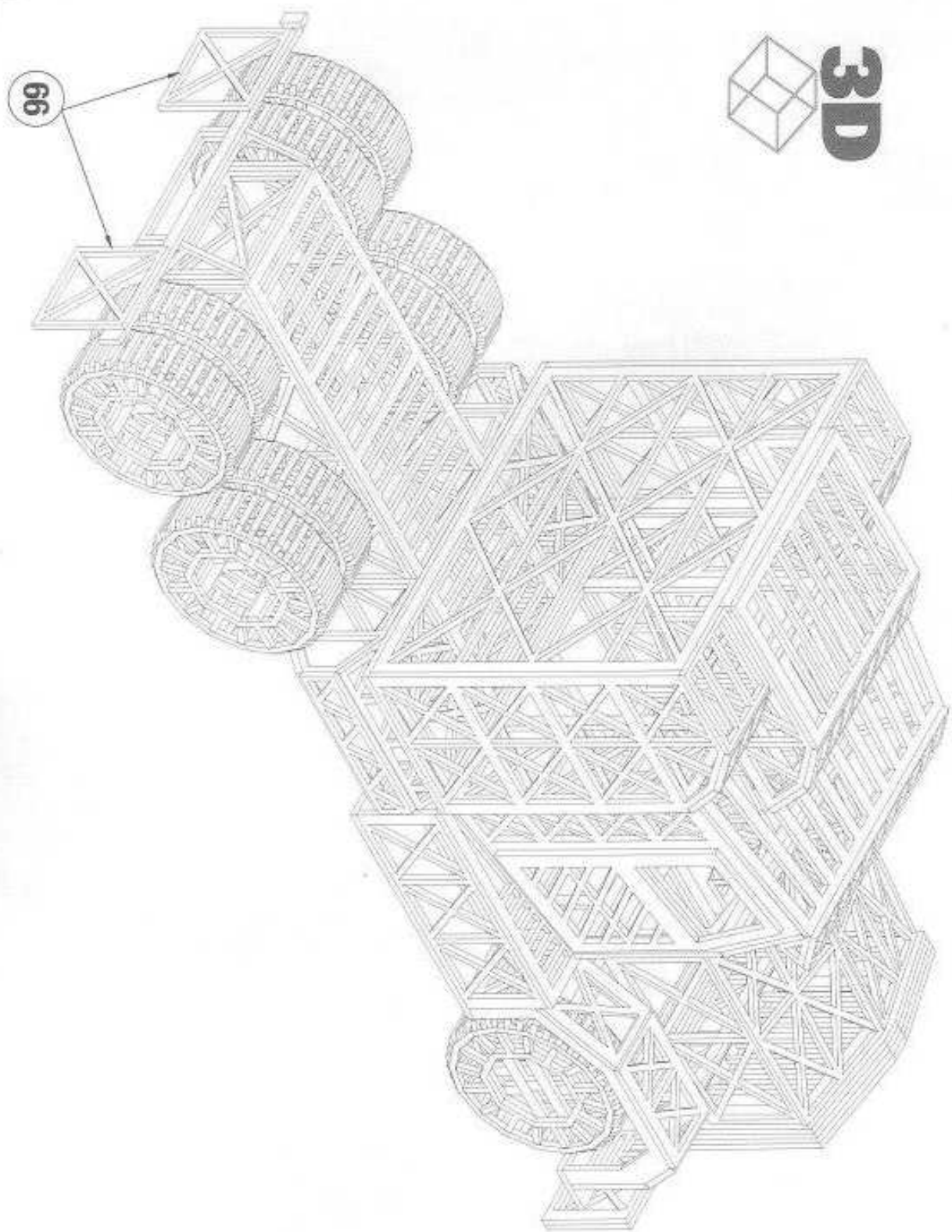

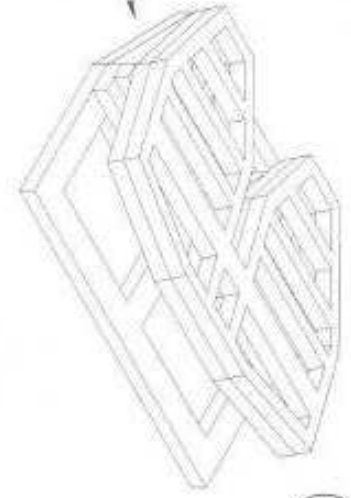
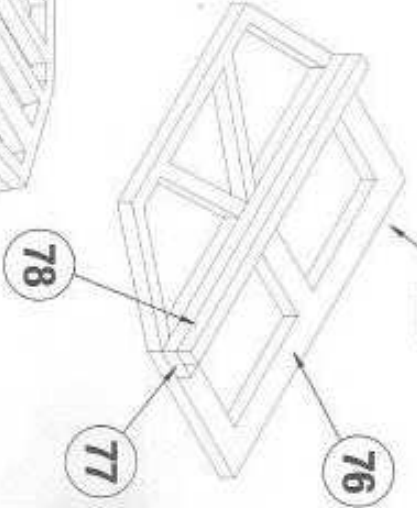
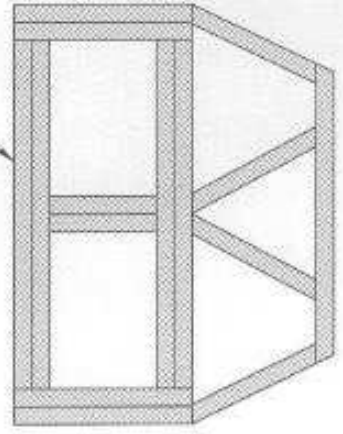
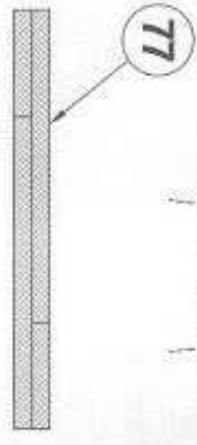
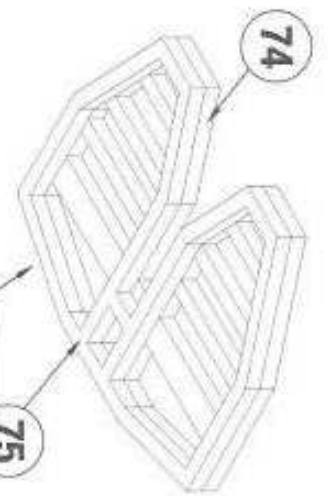
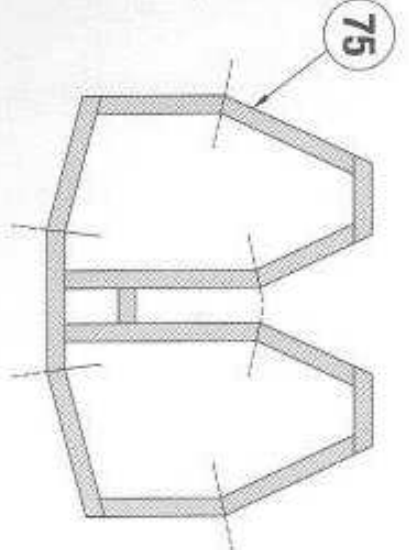
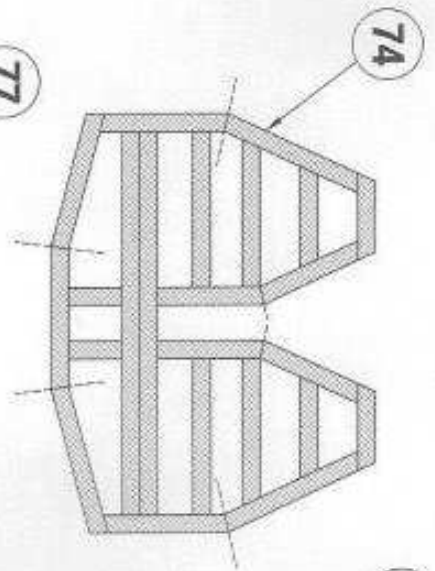

© 2004 Bopu, Inc.

www.matchitecture.com

MATCHITECTURE

**3D**

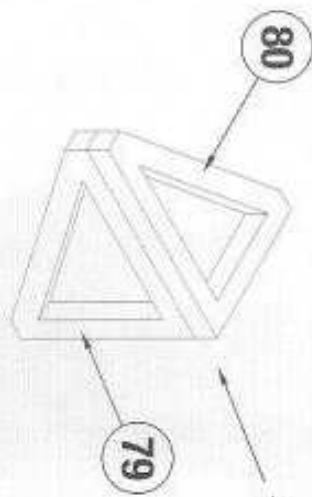

2x 79

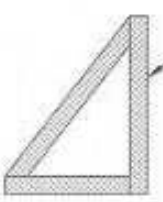

2x 80

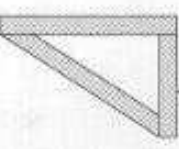

2x 81

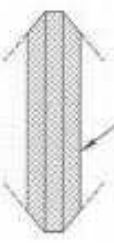

2x 82

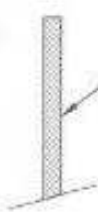

70

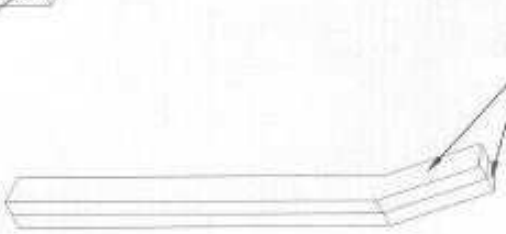

68



69



**3D**

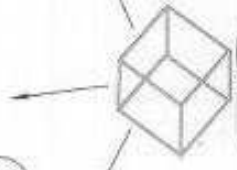

72

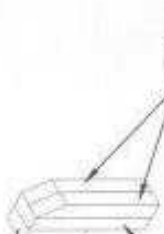

71

73

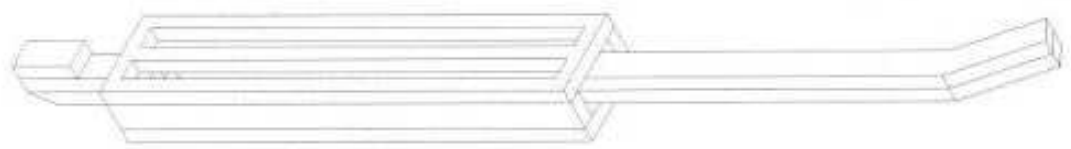
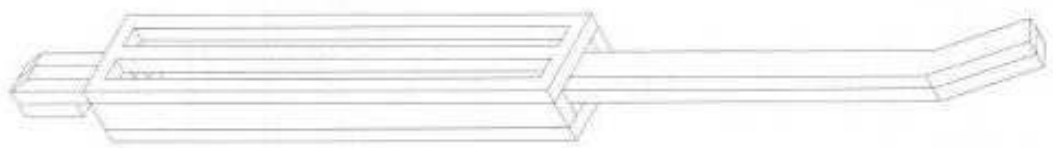

© 2004 Siquia Inc.

[www.matchitecture.com](http://www.matchitecture.com)

**MATCHITECTURE**

**3D**

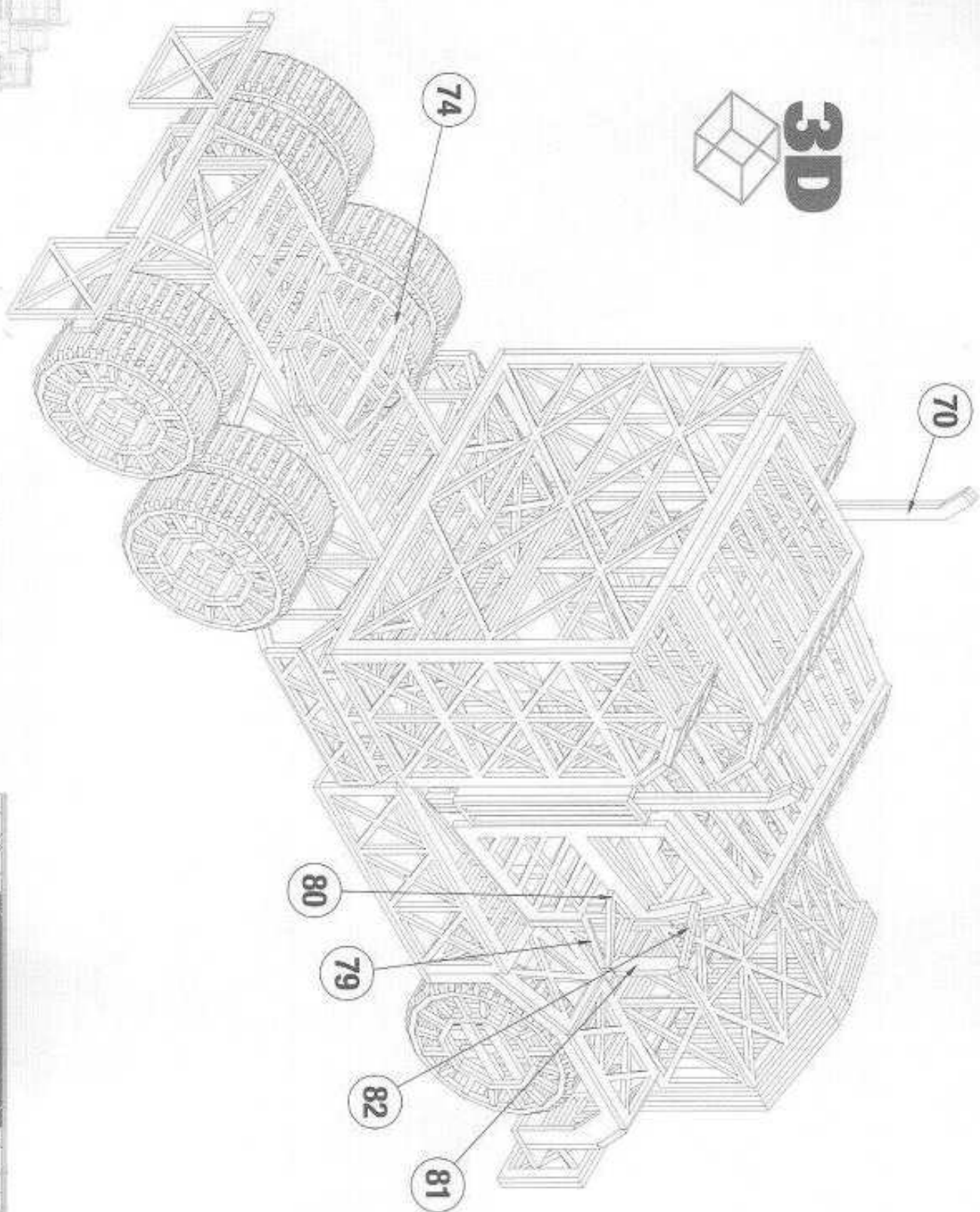

 **3D**

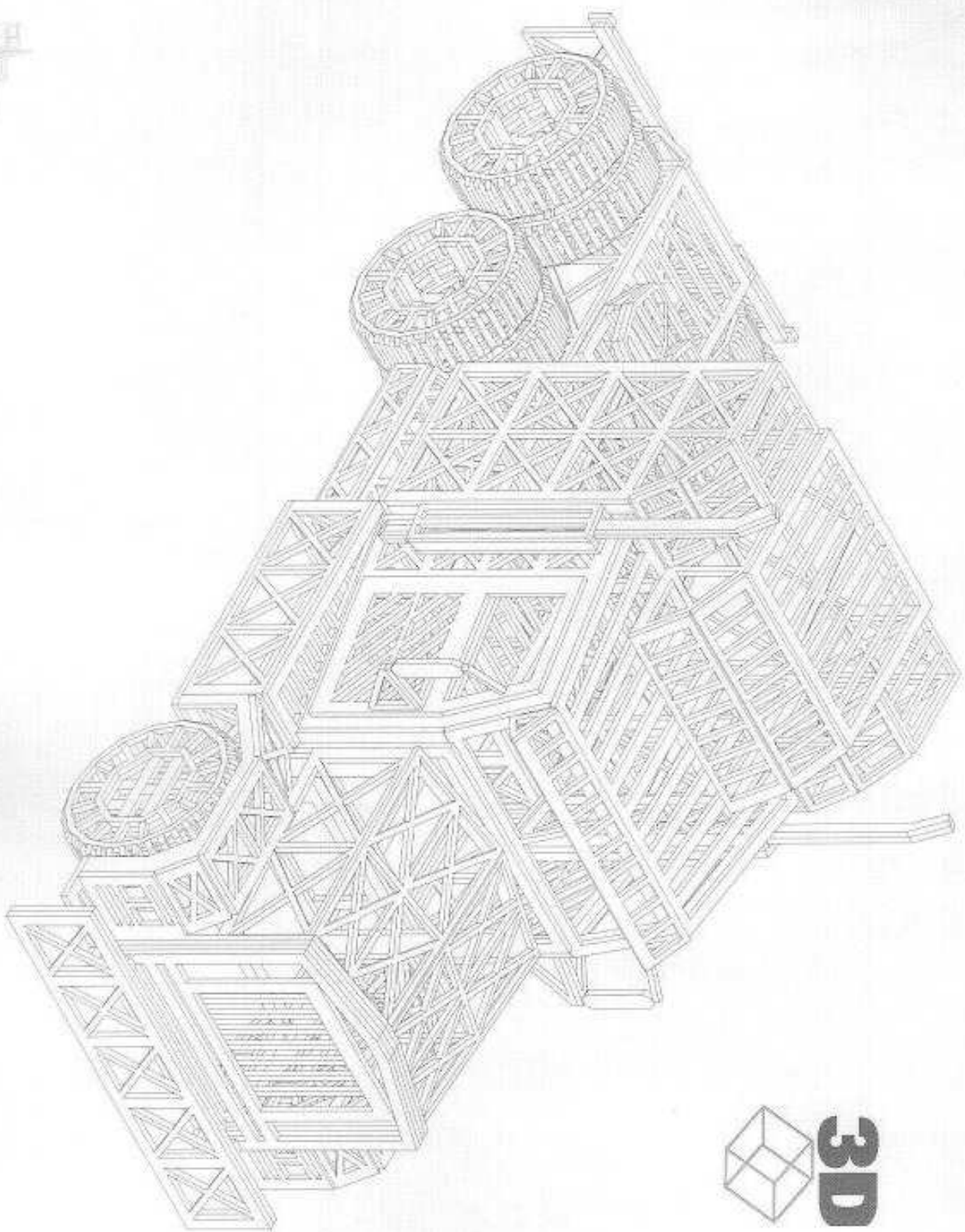

© 2004 Ejecta Inc.

[www.matchitecture.com](http://www.matchitecture.com)

**MATCHITECTURE**

**41** / **41**