

30

MalqueviczRonaldoM

PAPERROOM

1:25 CITROËN HY Hommage 70 ans - 2017



Citroën Type HY

Produced after the Second World War to meet the urgent needs of a commercial vehicle in the European post-war market. The Type H was an exceptional design due to its low cost and practicality qualities

The type H had a unitary body with no separate frame, four-wheel independent suspension, and front-wheel drive.

Traction avant 4 cylinder engine and the unsophisticated 3 speed gearbox

The engine and drivetrain well behind the front wheels axles, with very little overhangs, combined with sophisticated totally independent suspensions.

Nearly half a million "H" were built in over thirty-three years until 1981.



1:25

A4

Difficulty



255 PARTS

By MalqueviczRonaldoM & Forum en papier

<http://paperoom.blogspot.com/>

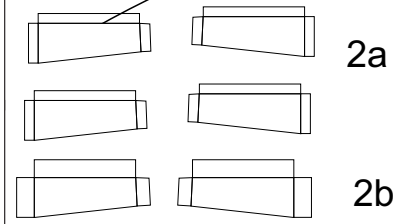
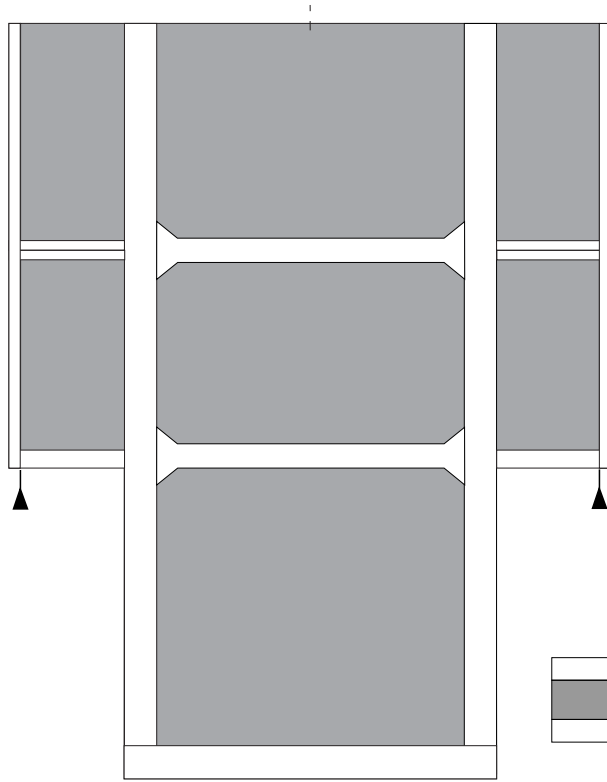

Suivez le tutoriel sur le forum en papier à l'adresse ci-dessous

<http://www.maquettes-papier.net/forumenpapier/viewtopic.php?f=36&t=13659>

2

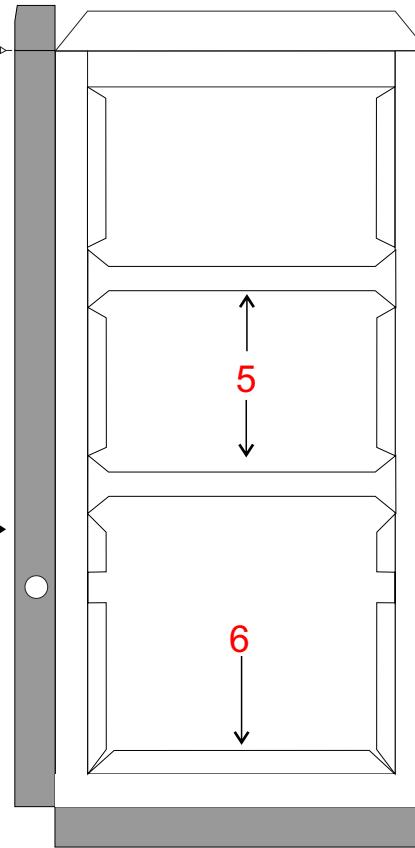
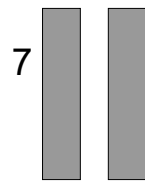
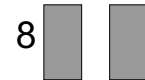
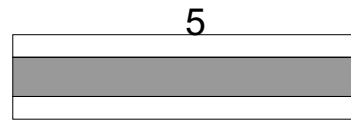
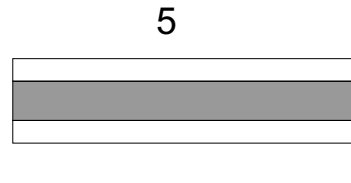

6

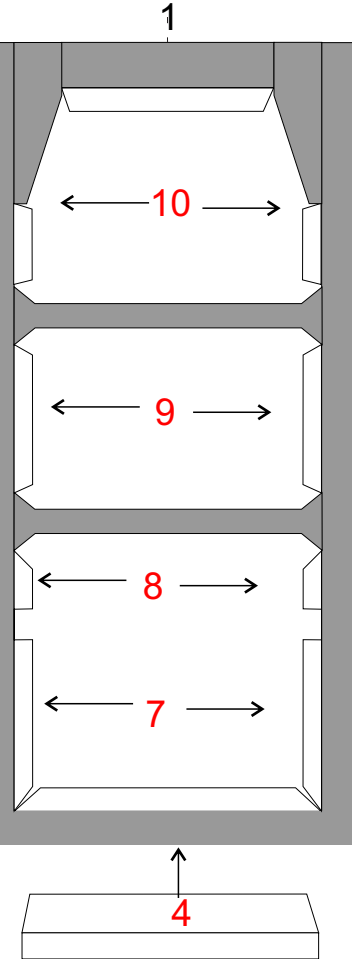

1

10

9

4

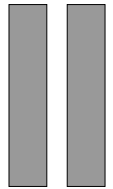
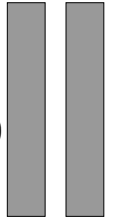



PIÈCE SUR CARTON

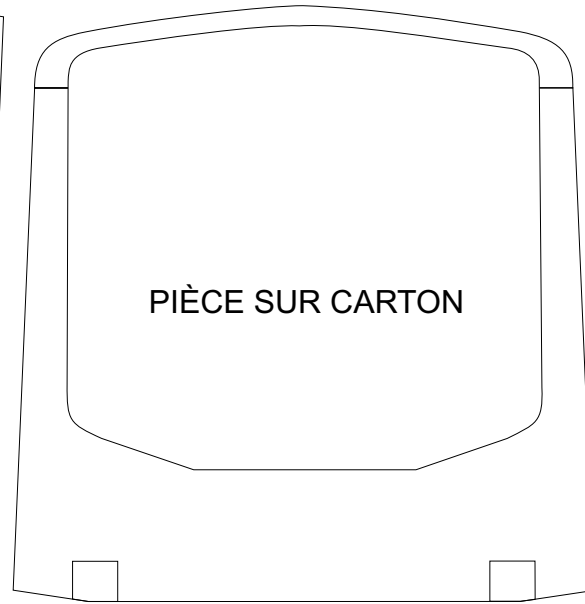

PIÈCE SUR CARTON

Suivez le tutoriel sur le forum en papier à l'adresse ci-dessous

<http://www.maquettes-papier.net/forumenpapier/viewtopic.php?f=36&t=13659>

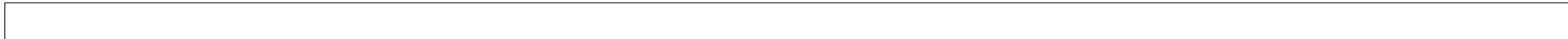

BANDES LATÉRALES

CAISSES DE ROUES

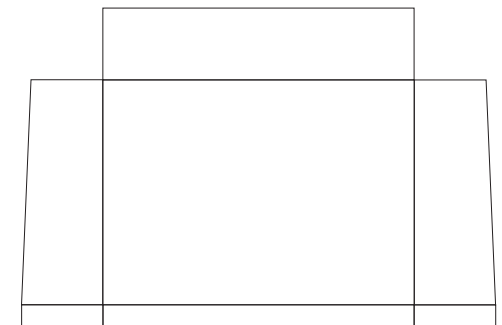
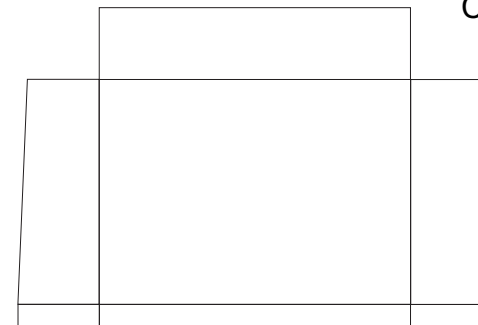
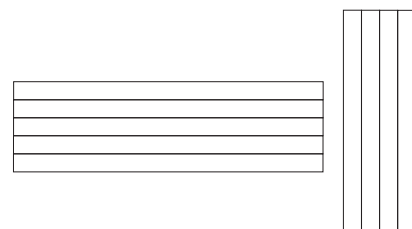
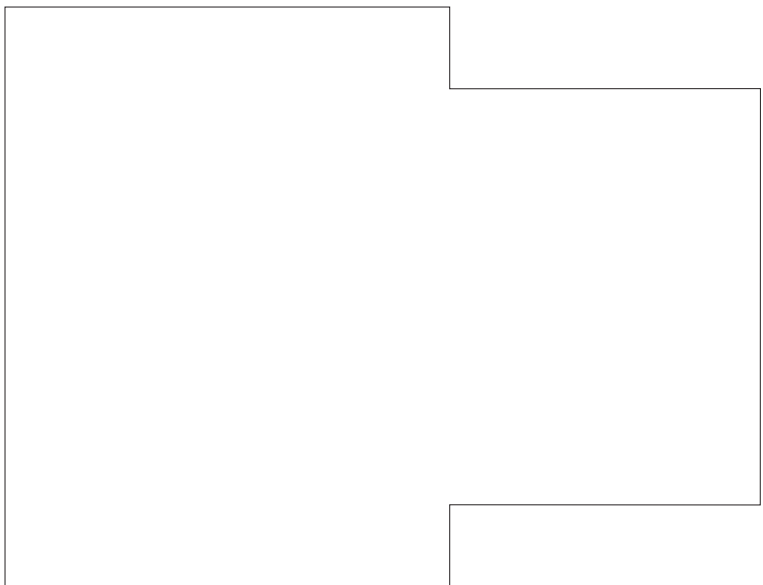
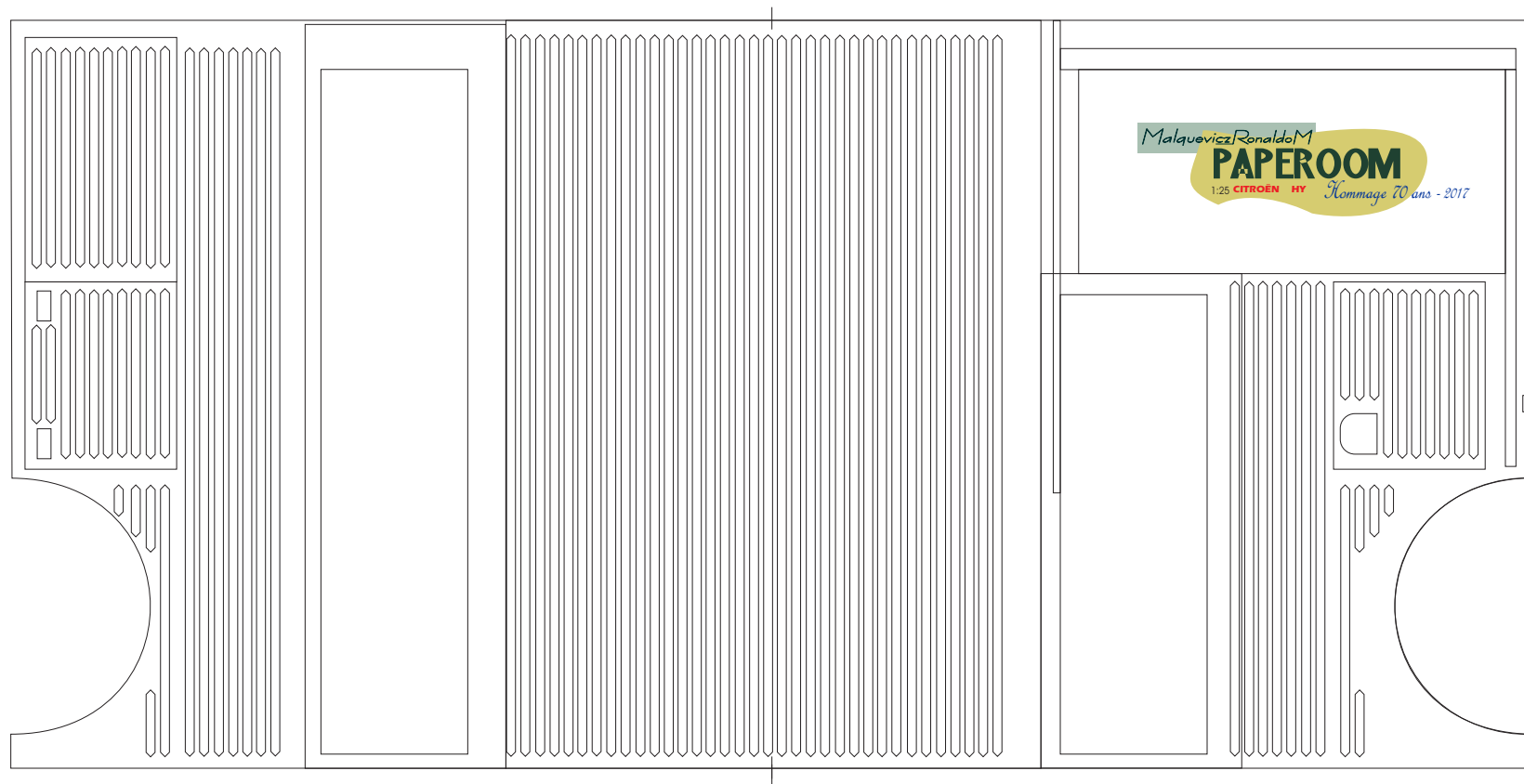

Plate-forme



Suivez le tutoriel sur le forum en papier à l'adresse ci-dessous

<http://www.maquettes-papier.net/forumenpapier/viewtopic.php?f=36&t=13659>



MalqueviczRonaldoM
PAPERROOM
1:25 CITROËN HY Hommage 70 ans - 2017

Pièce sur carton

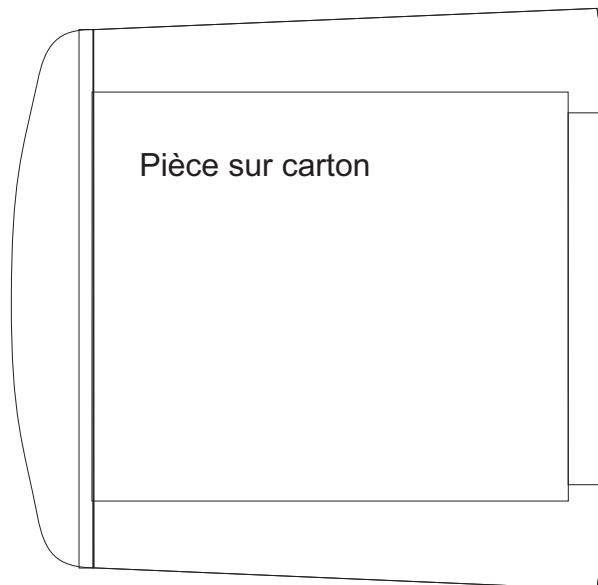

1:25

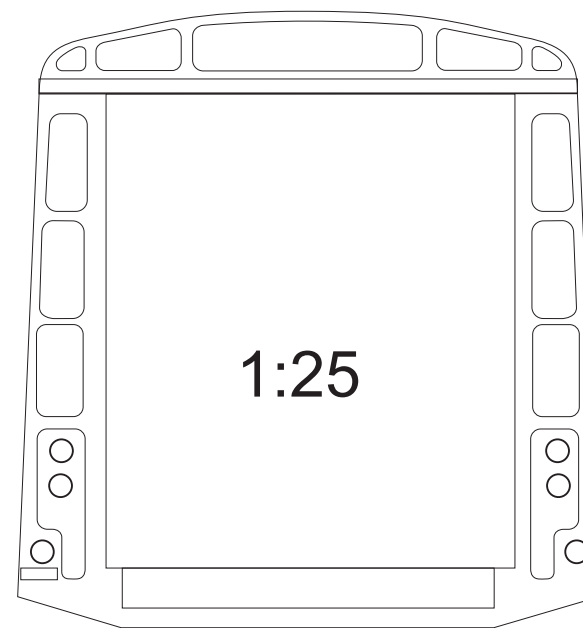

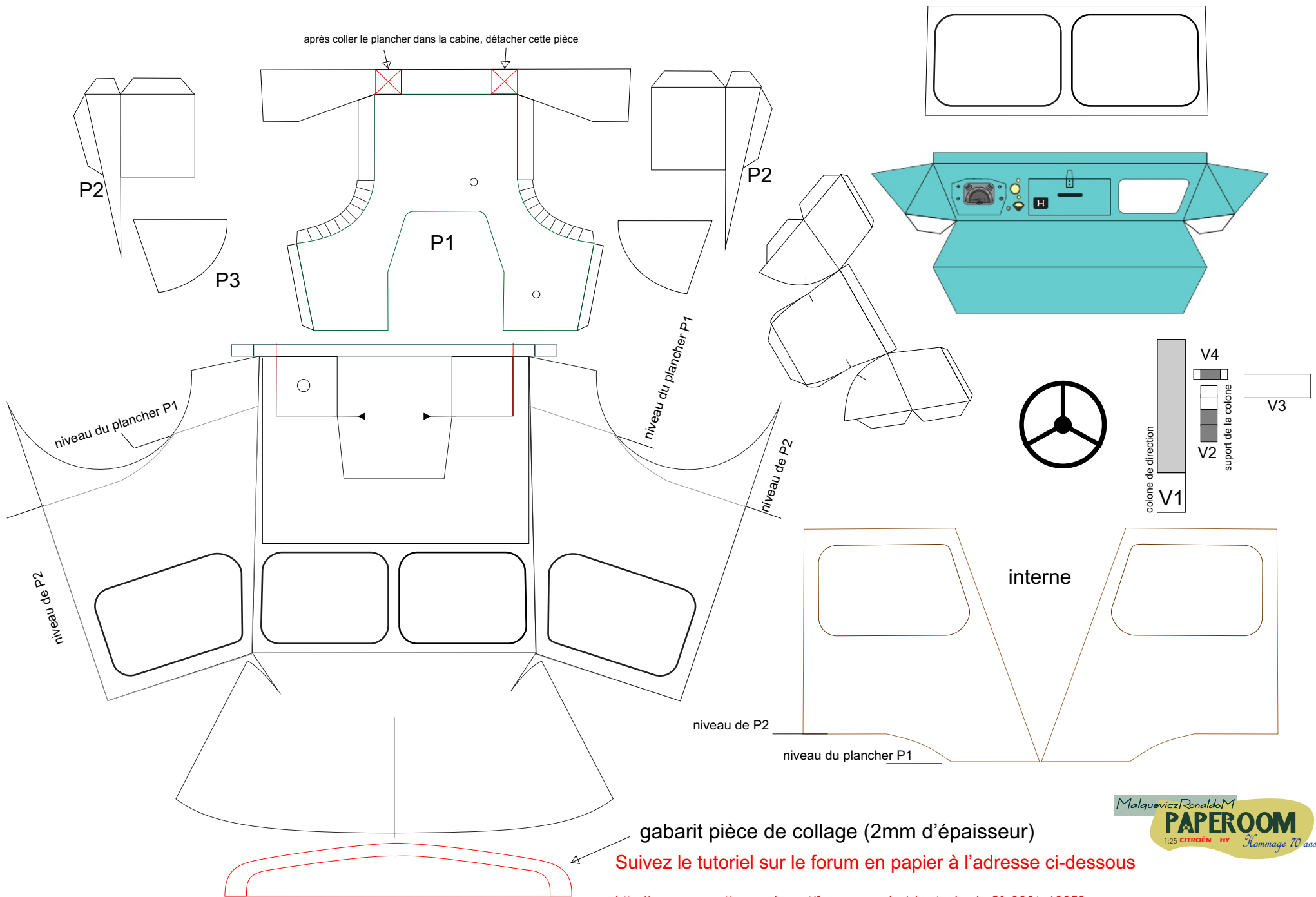

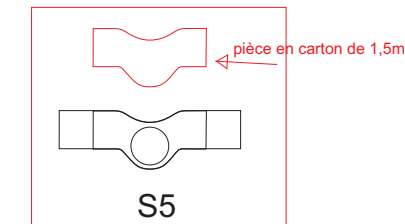
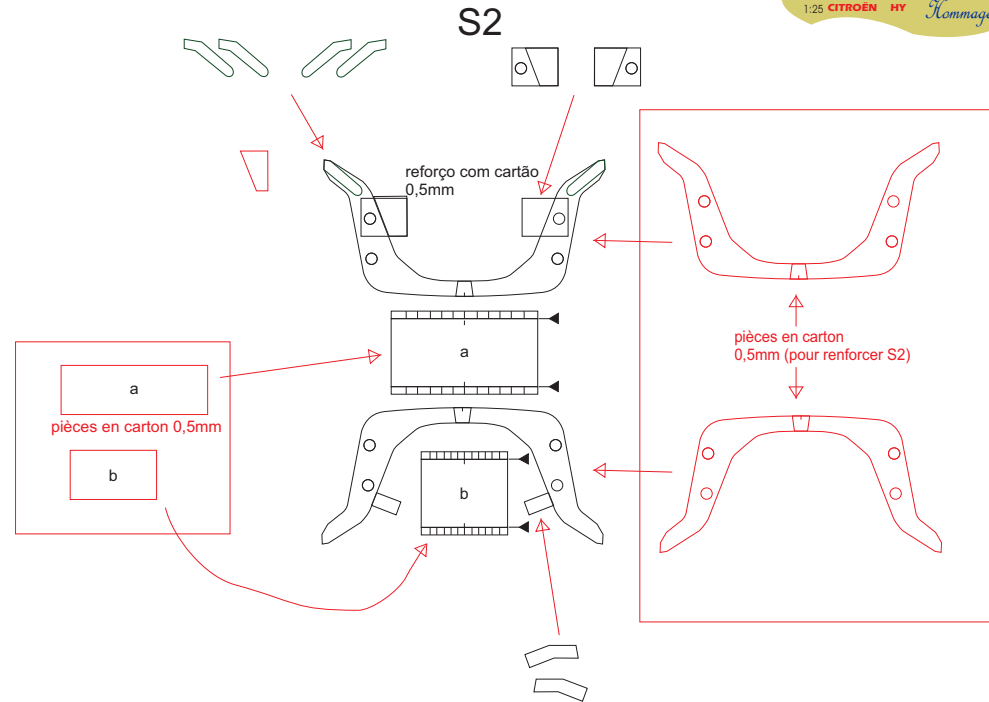
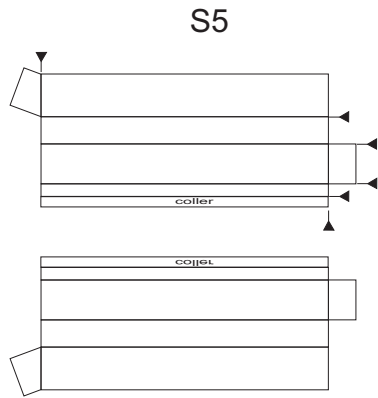
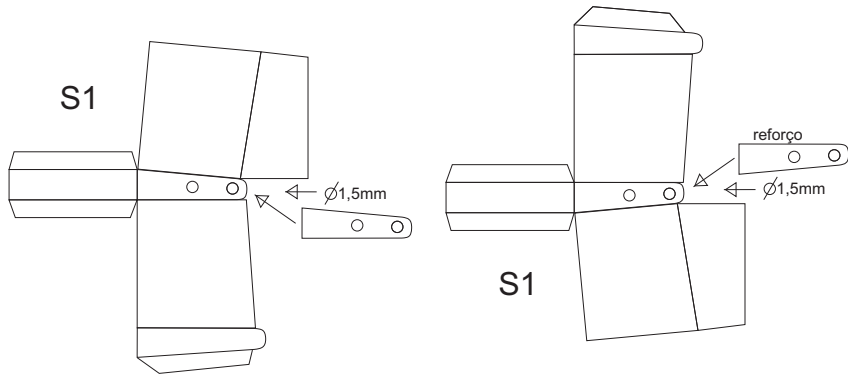

Suivez le tutoriel sur le forum en papier à l'adresse ci-dessous

<http://www.maquettes-papier.net/forumenpapier/viewtopic.php?f=36&t=13659>

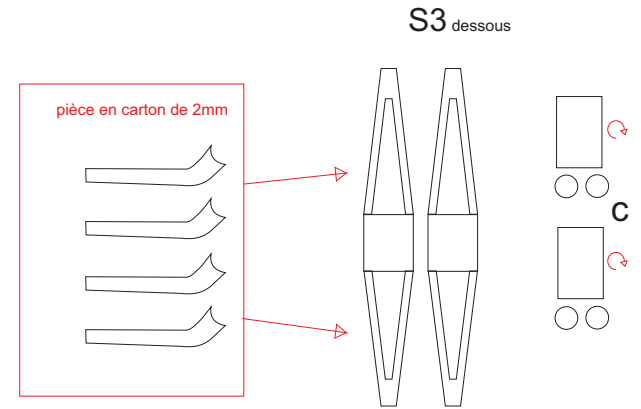
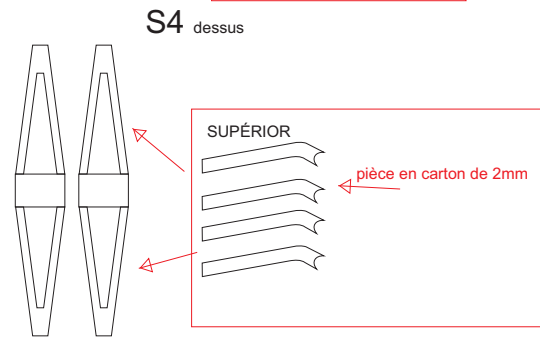
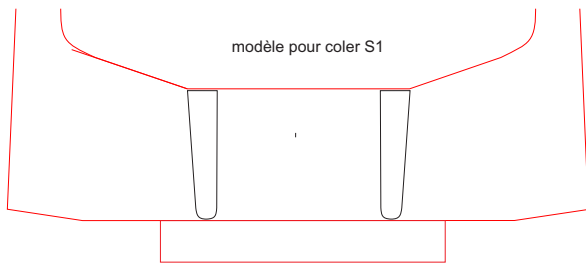

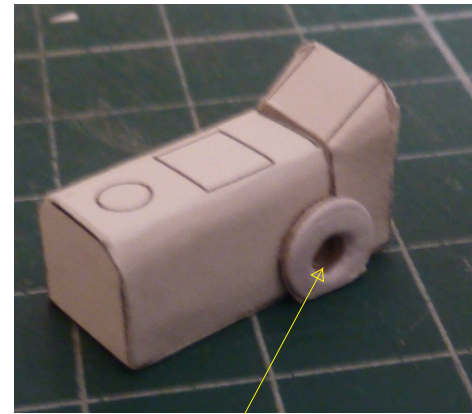
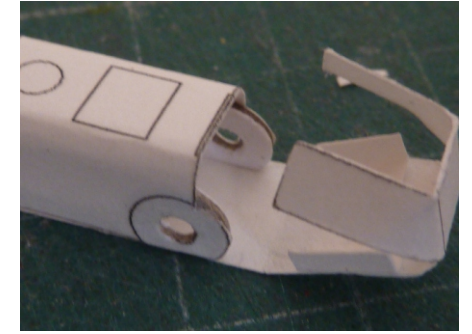
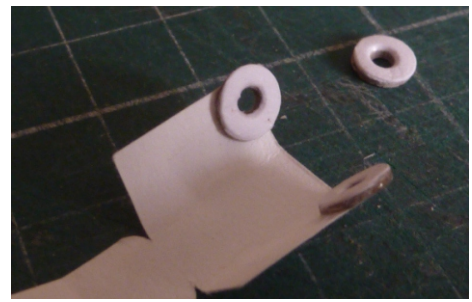
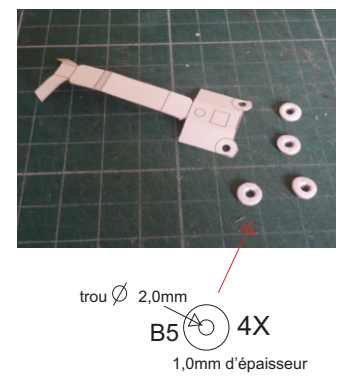
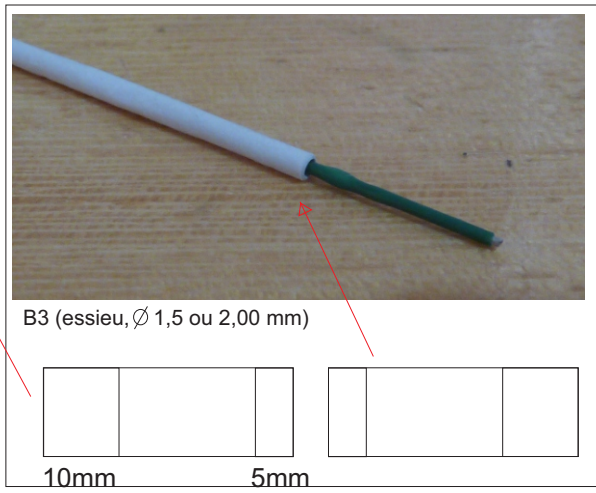
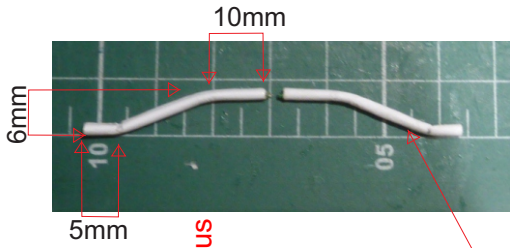

Mettez ici l'essieu B3

Suivez le tutoriel sur le forum en papier à l'adresse ci-dessous

<http://www.maquettes-papier.net/forumenpapier/viewtopic.php?f=36&t=13659>

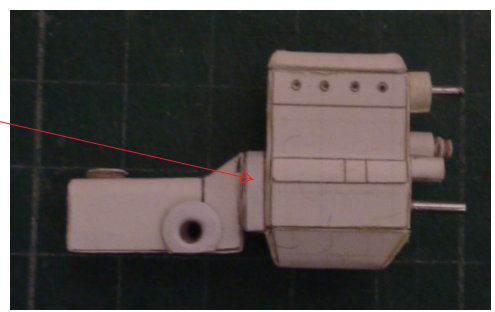
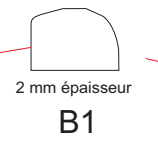
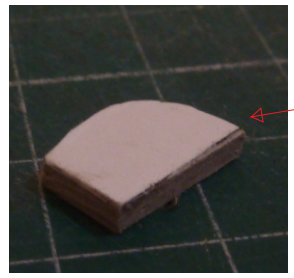
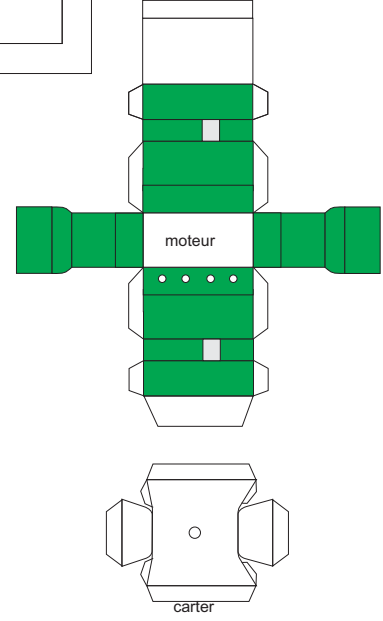
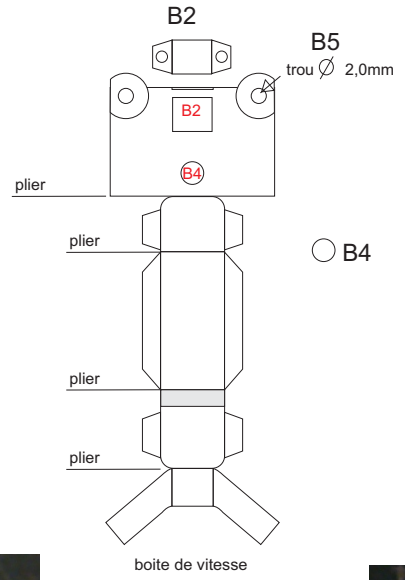

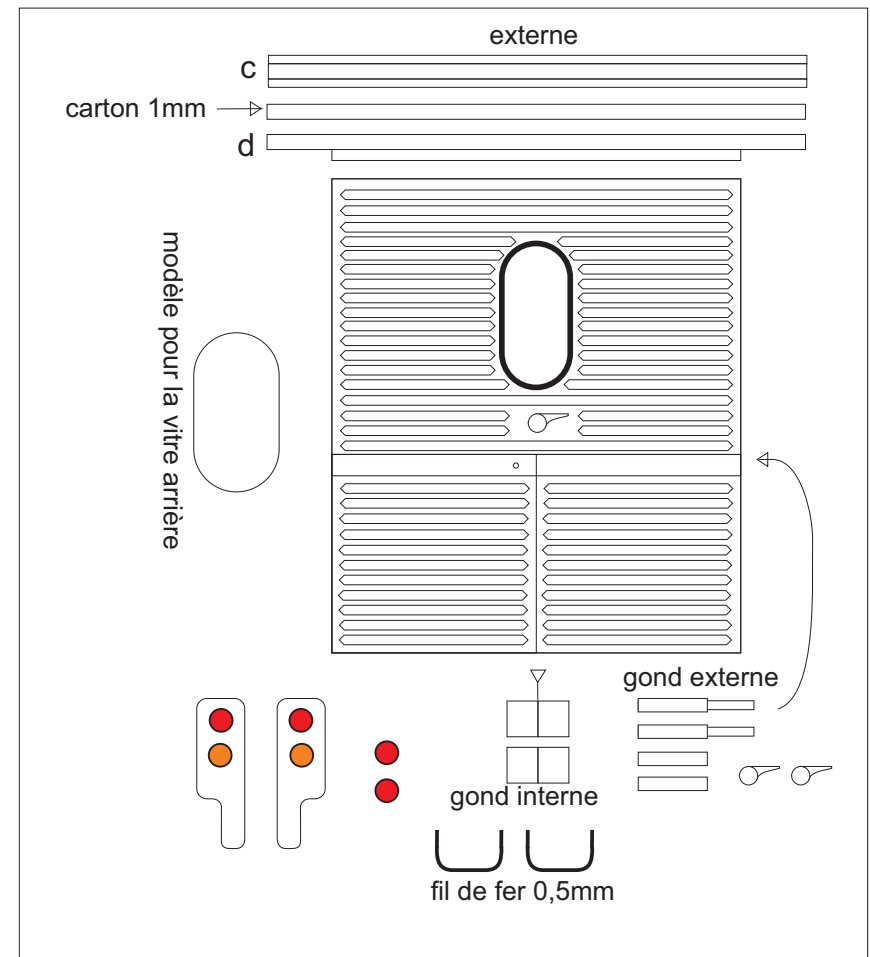
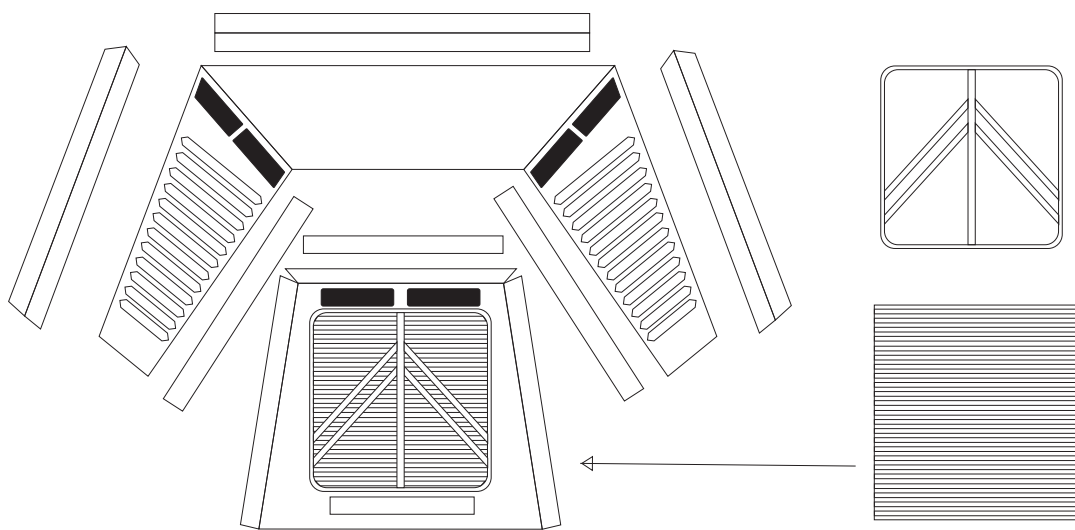
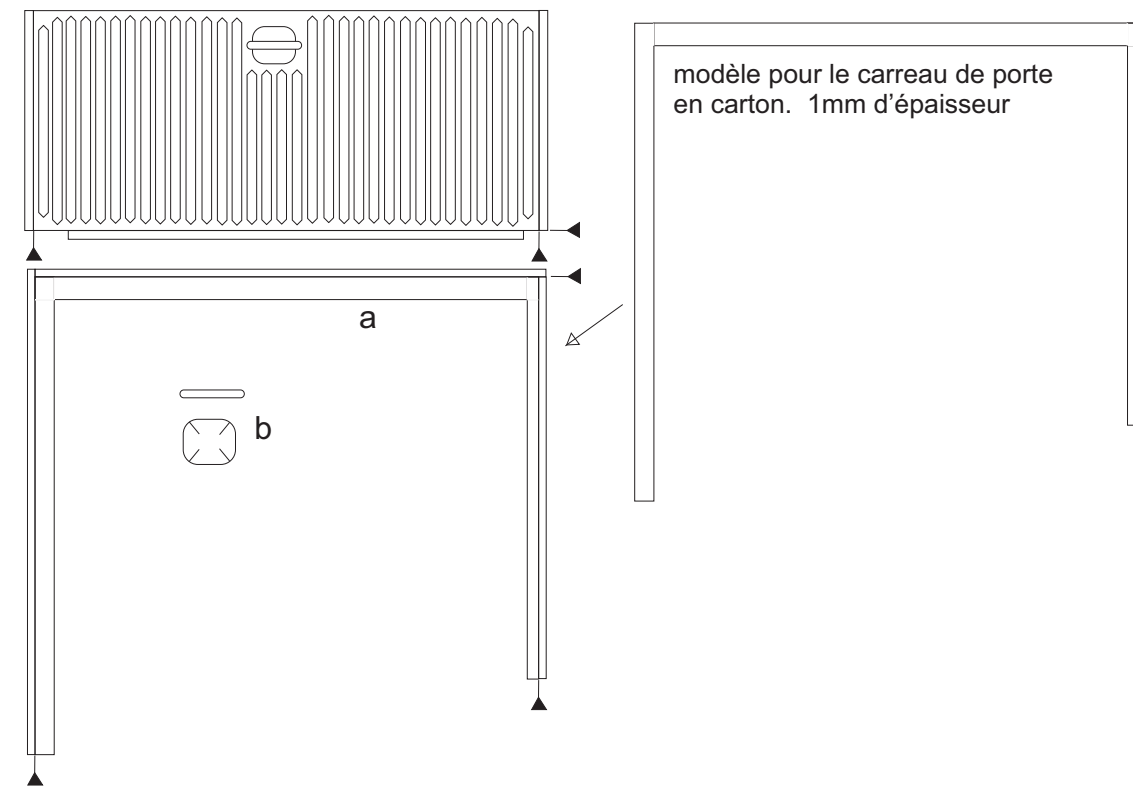

Suivez le tutoriel sur le forum en papier à l'adresse ci-dessous

<http://www.maquettes-papier.net/forumenpapier/viewtopic.php?f=36&t=13659>

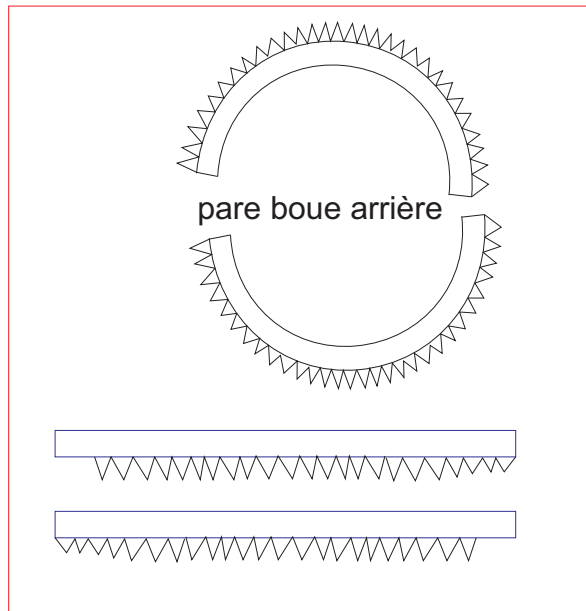
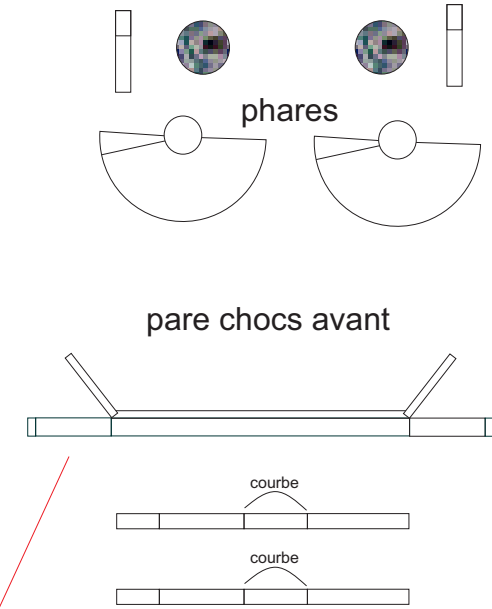
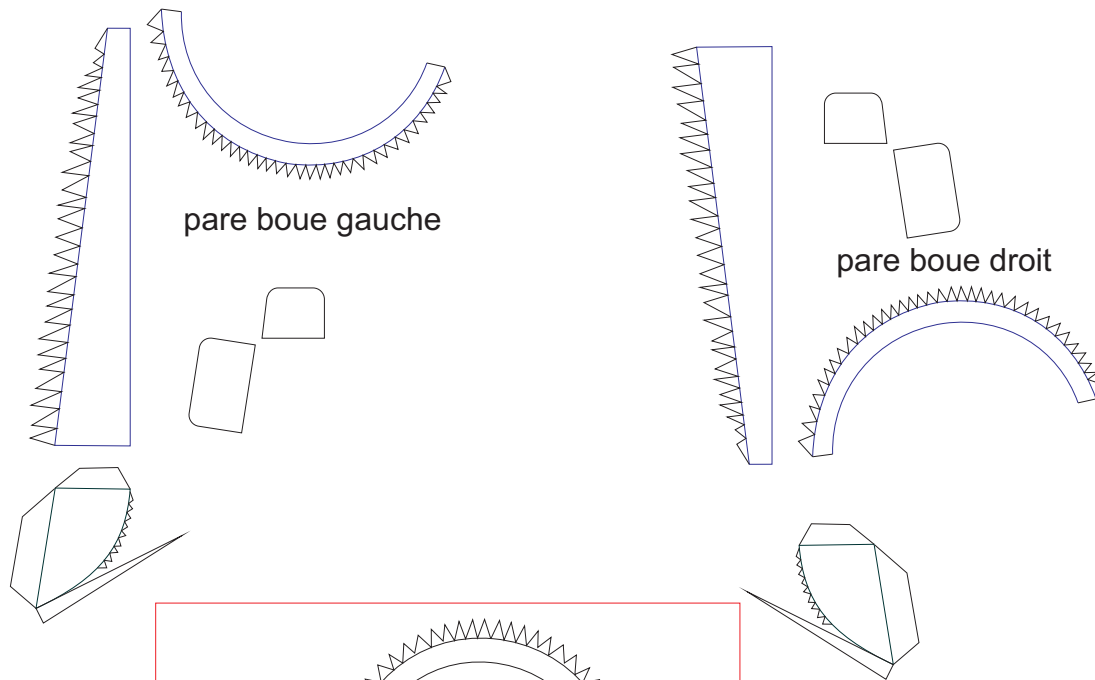

Suivez le tutoriel sur le forum en papier à l'adresse ci-dessous

<http://www.maquettes-papier.net/forumenpapier/viewtopic.php?f=36&t=13659>

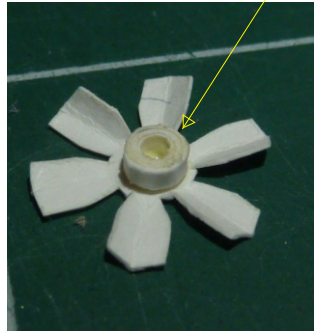
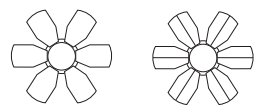
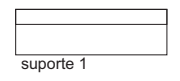
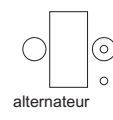
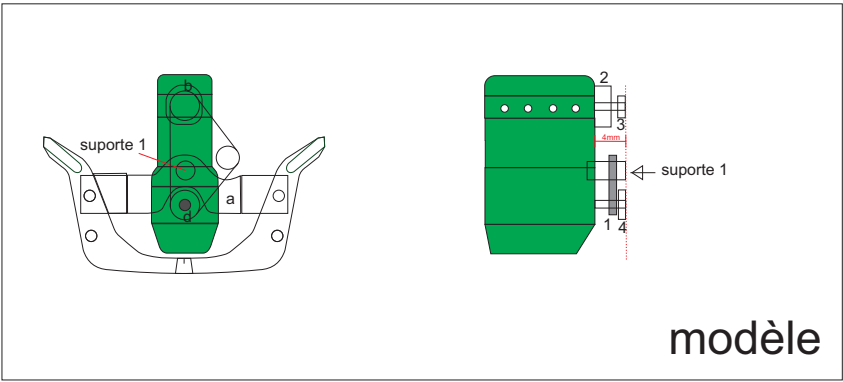

Suivez le tutoriel sur le forum en papier à l'adresse ci-dessous

<http://www.maquettes-papier.net/forumenpapier/viewtopic.php?f=36&t=13659>

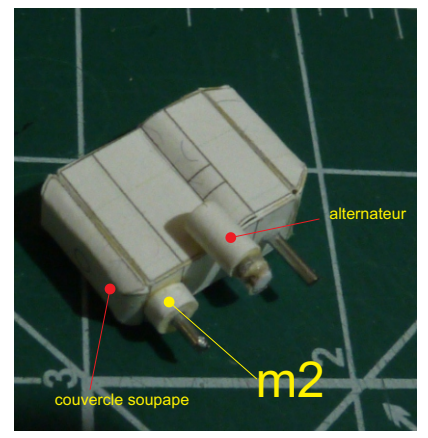
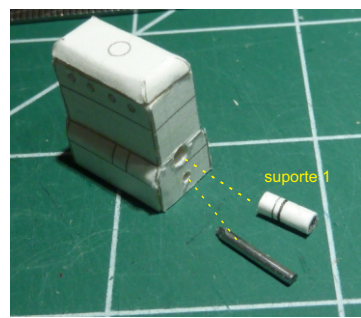
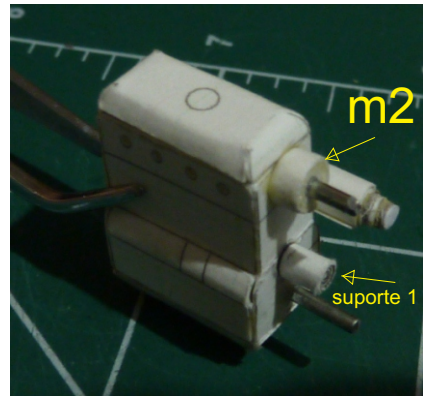
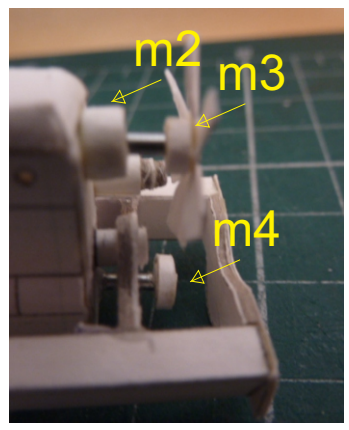
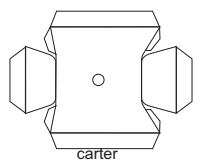
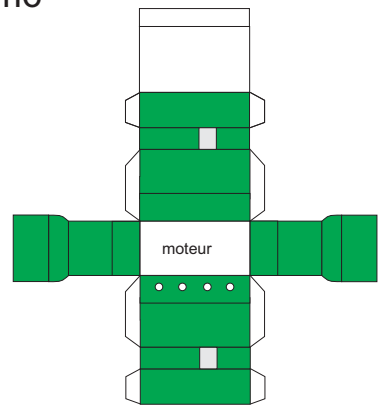
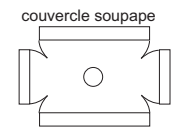
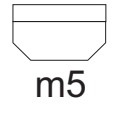
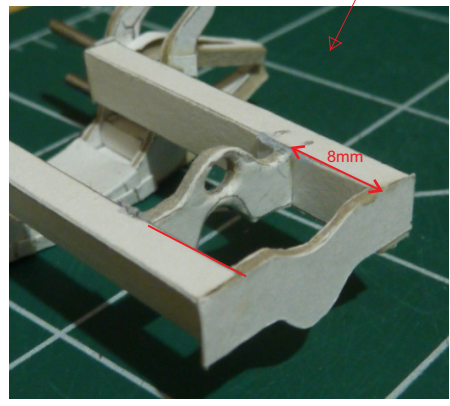
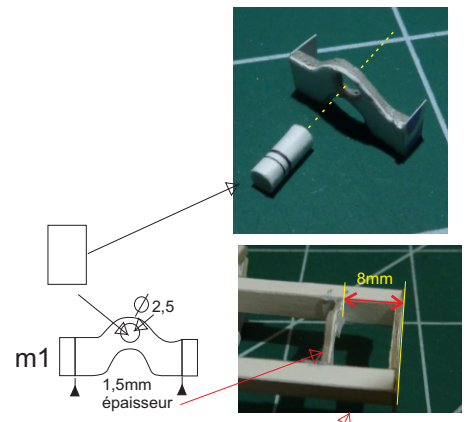

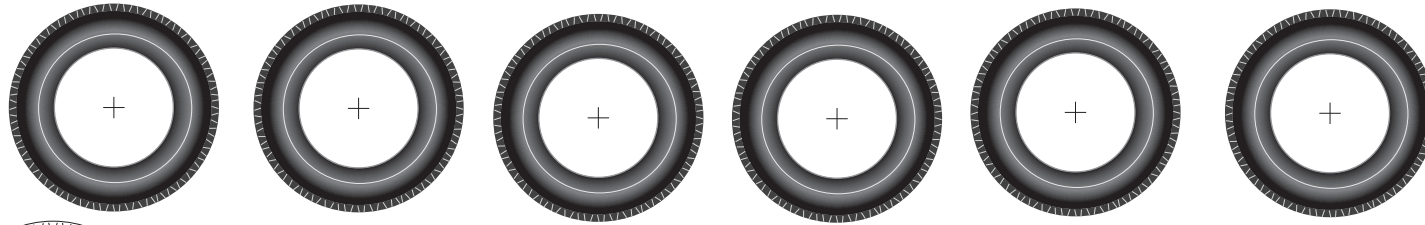
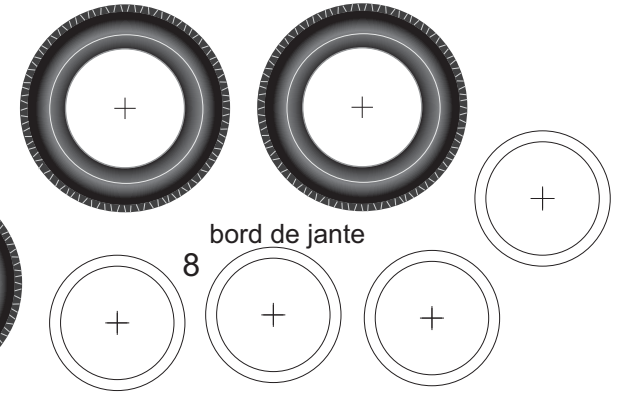
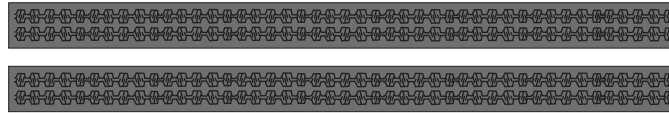
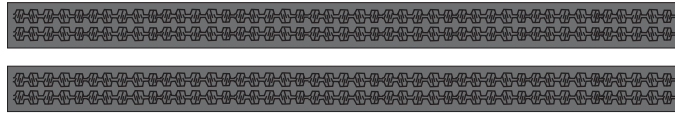

bord de jante

8

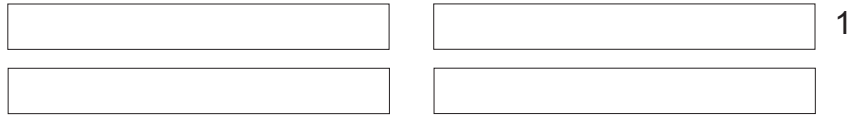
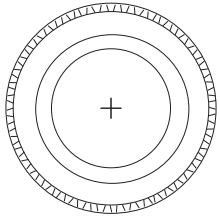

1

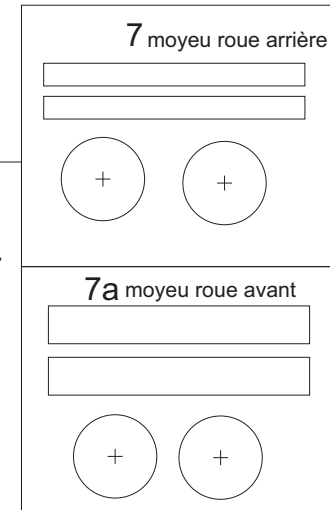

7 moyeu roue arrière

7a moyeu roue avant

9

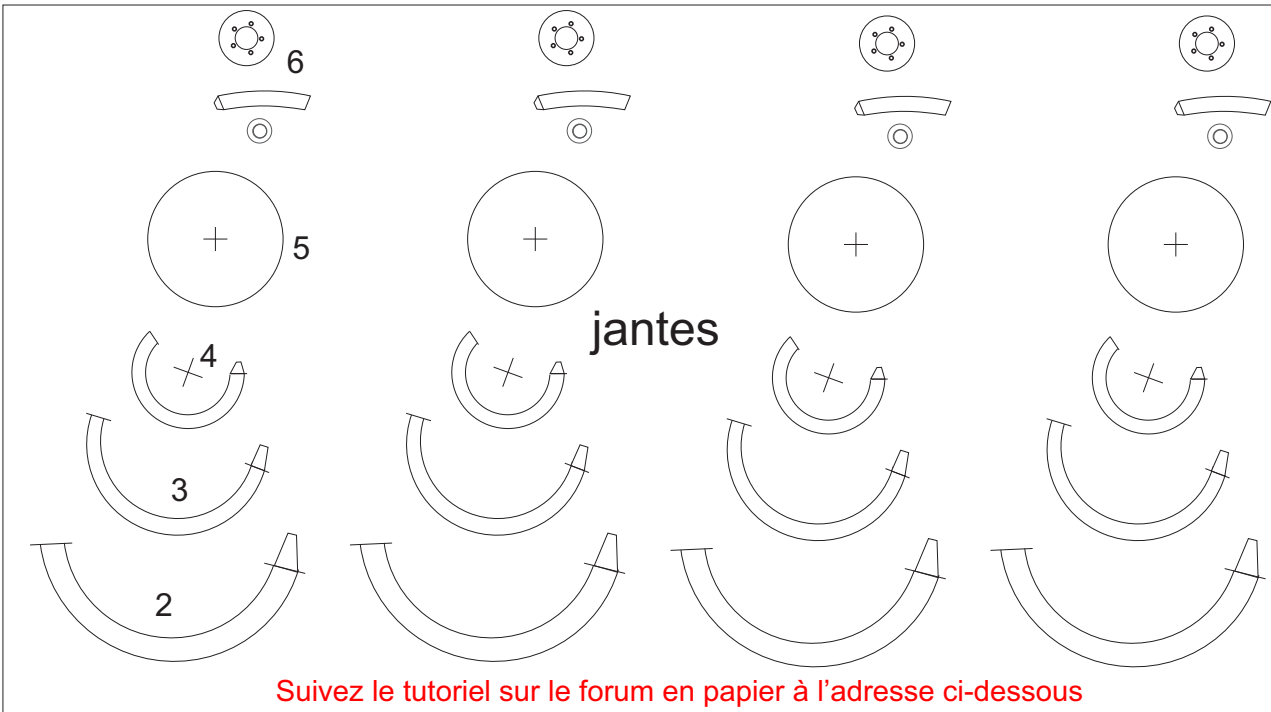
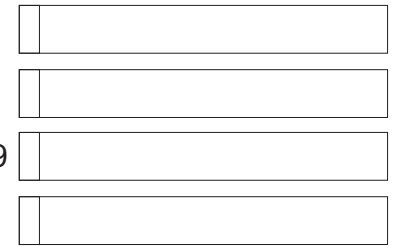

jantes

Suivez le tutoriel sur le forum en papier à l'adresse ci-dessous

<http://www.maquettes-papier.net/forumenpapier/viewtopic.php?f=36&t=13659>

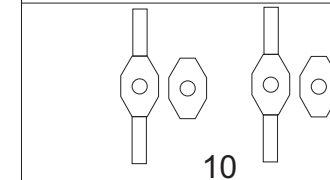

10

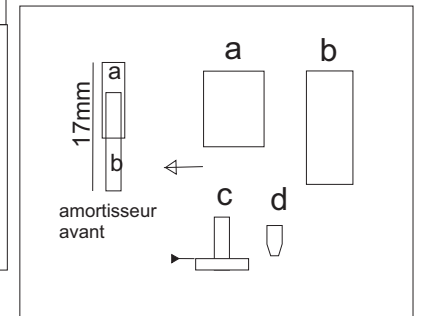

amortisseur avant

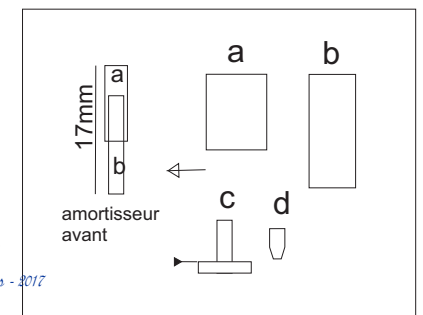

amortisseur avant



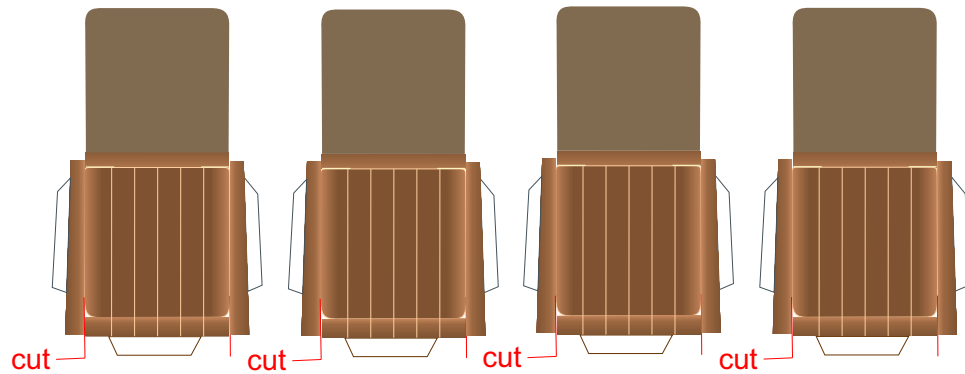
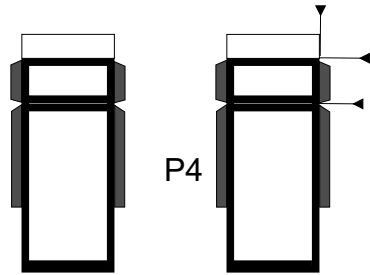
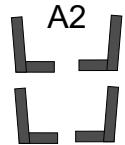
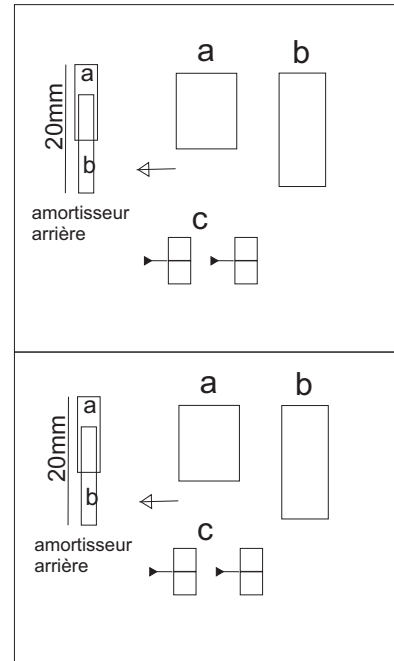
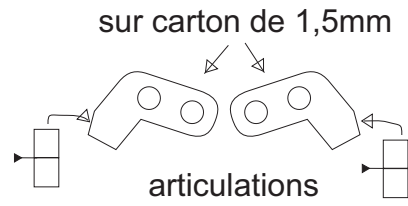
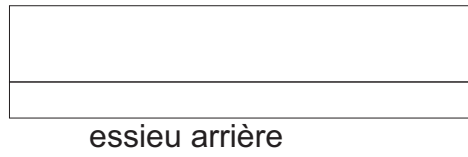

Suivez le tutoriel sur le forum en papier à l'adresse ci-dessous

<http://www.maquettes-papier.net/forumenpapier/viewtopic.php?f=36&t=13659>