

4 X H =

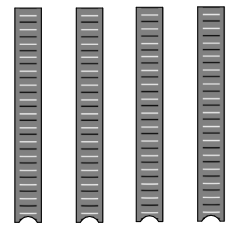

h

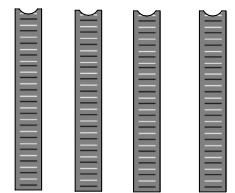
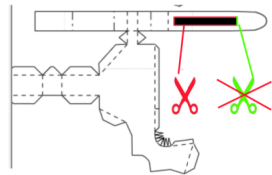

m

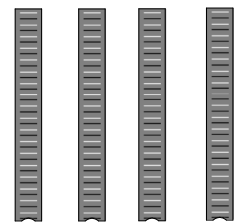
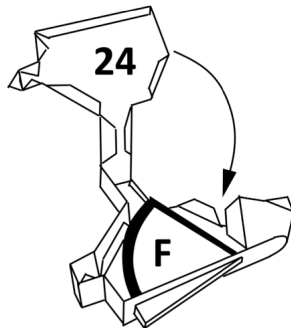
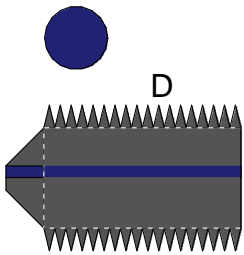

b

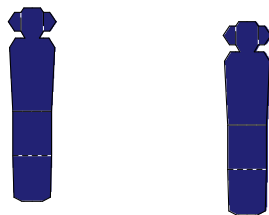

6 x B

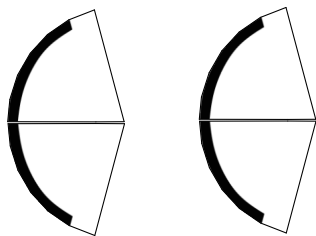
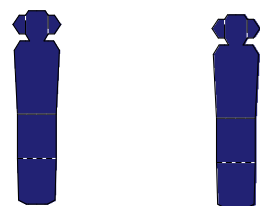
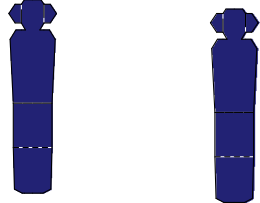

4 x F

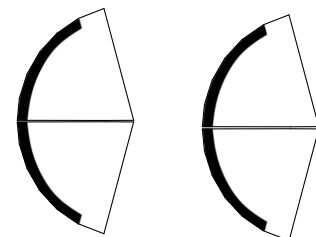

4 X I

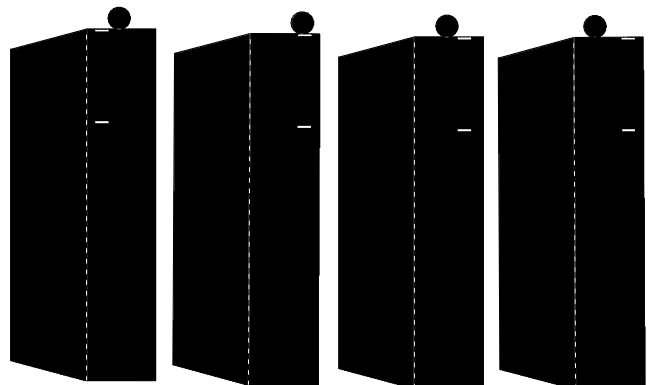



1

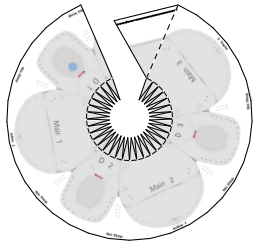

2

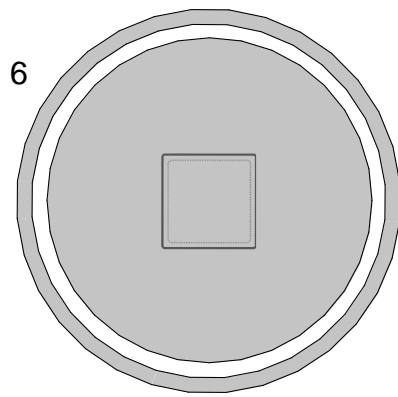

6

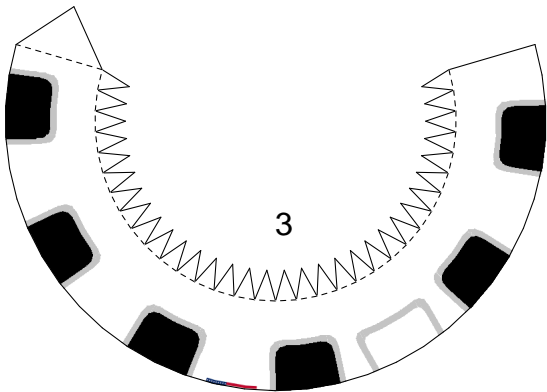

3

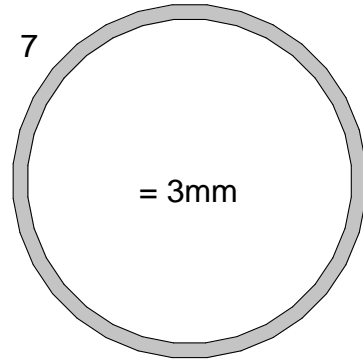

7

= 3mm

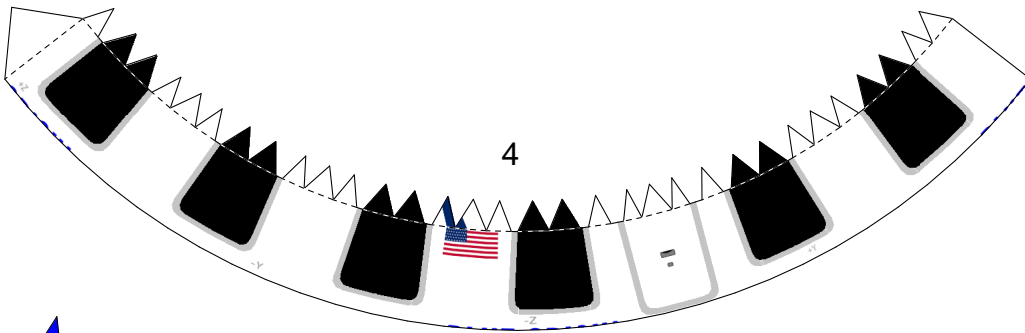

4

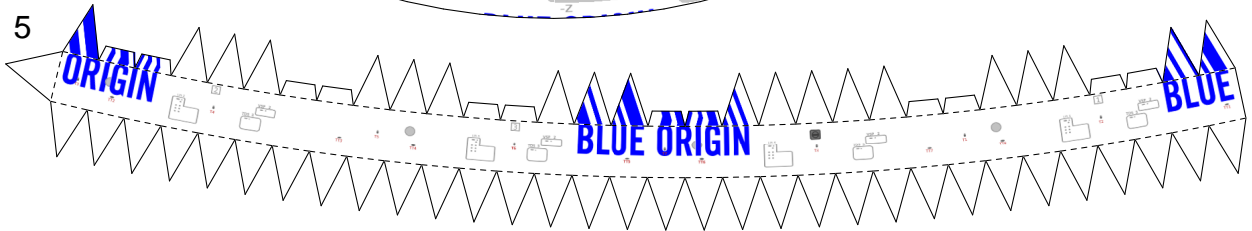

5

ORIGIN

BLUE ORIGIN

BLUE

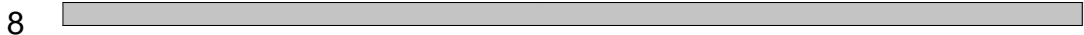

8

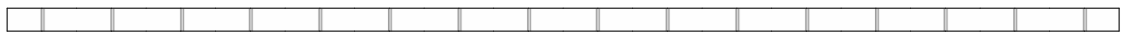

9

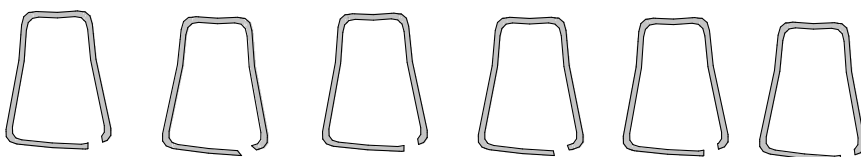

6 x 10

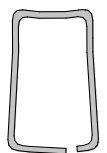

11

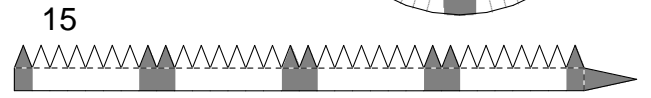
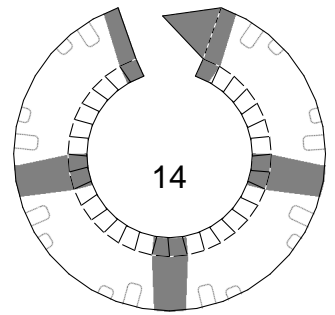
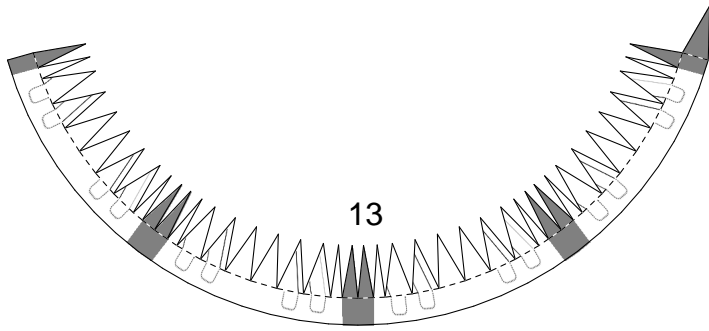

12

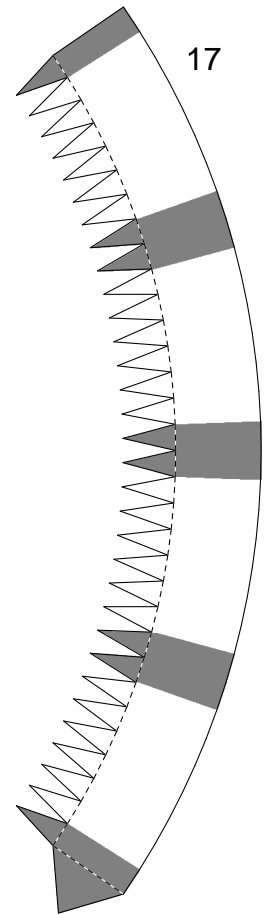
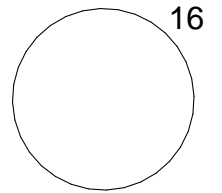

17

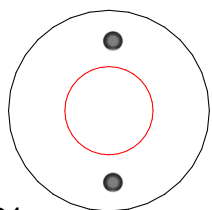

21

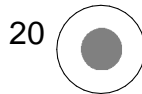

20



22

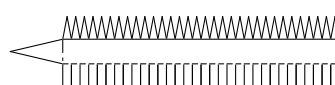

19

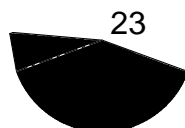

23

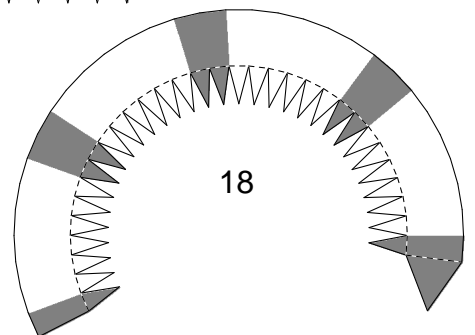

18

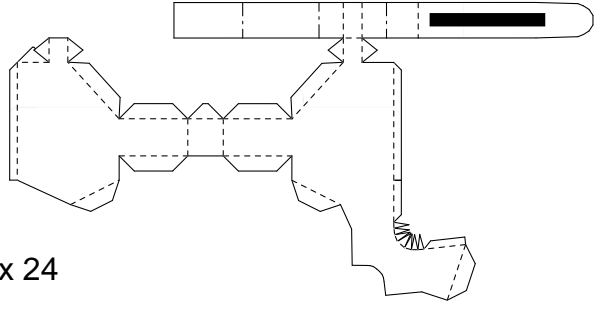
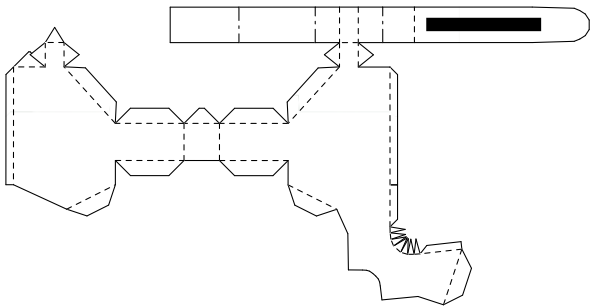

4 x 24

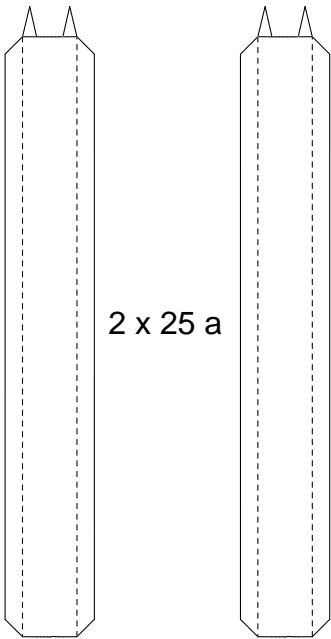
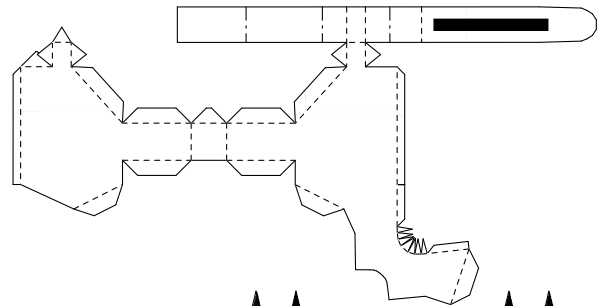
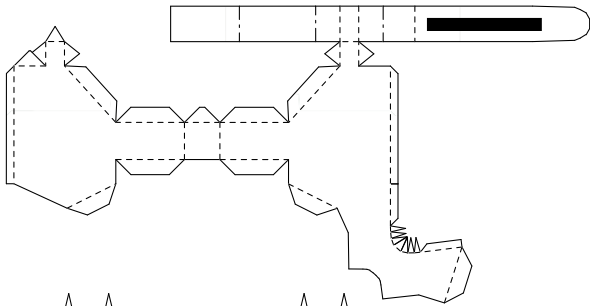

2 x 25 a

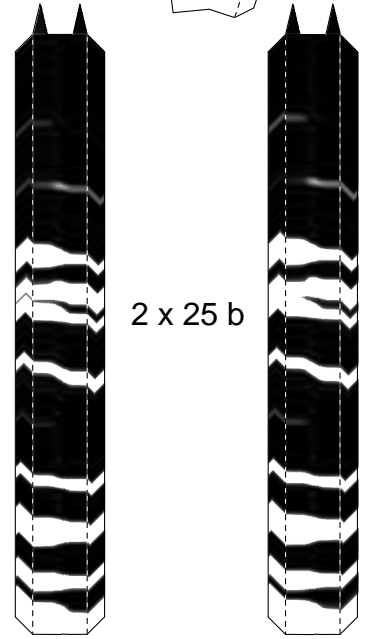

2 x 25 b

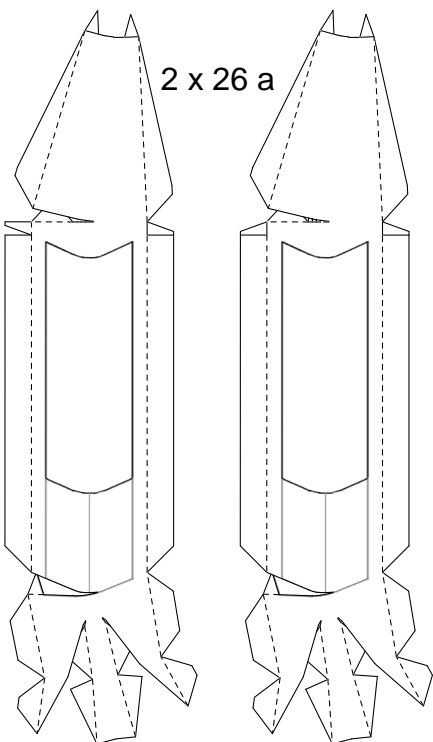

2 x 26 a

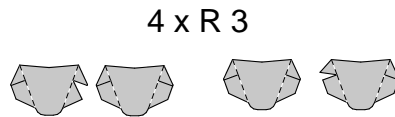

4 x R 3

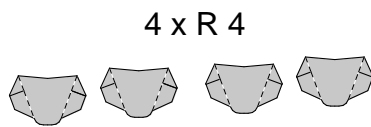

4 x R 4

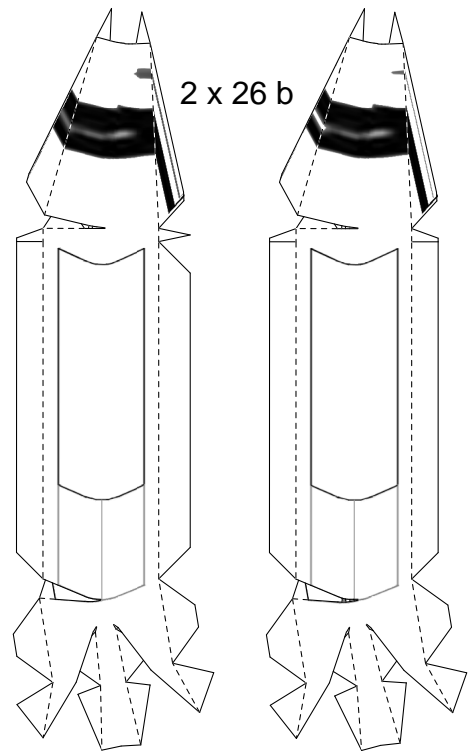

2 x 26 b

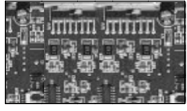
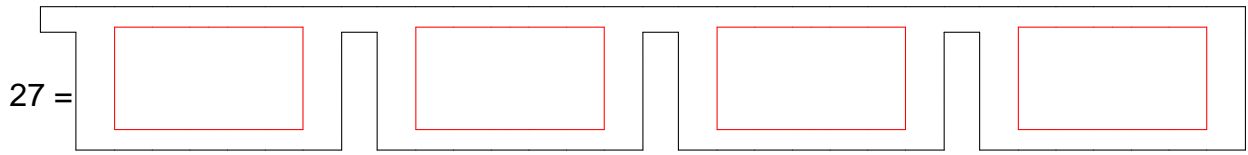

4 X 29

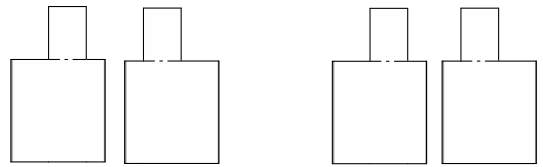
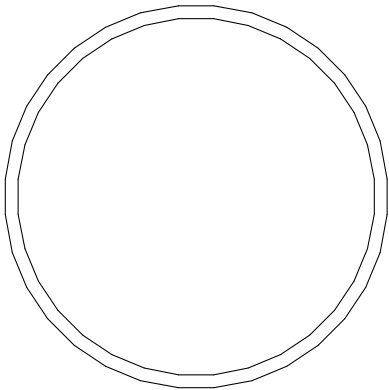
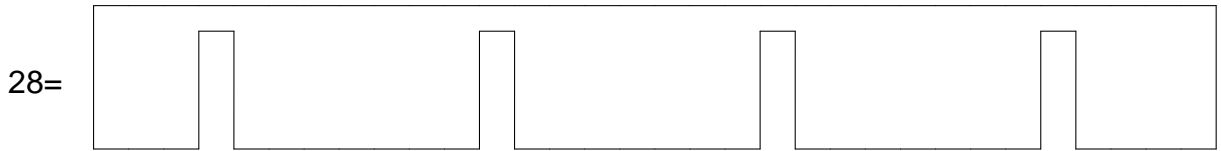
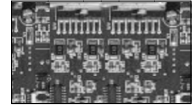
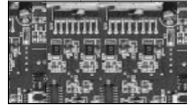
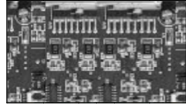

4 x 30

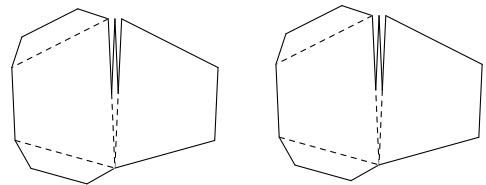
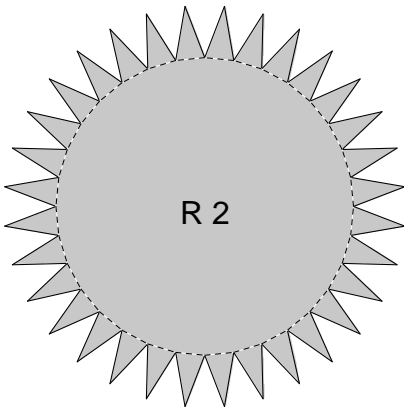
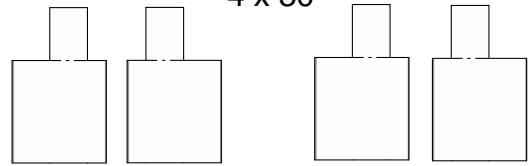

4 x 31

