

upper

middle

lower

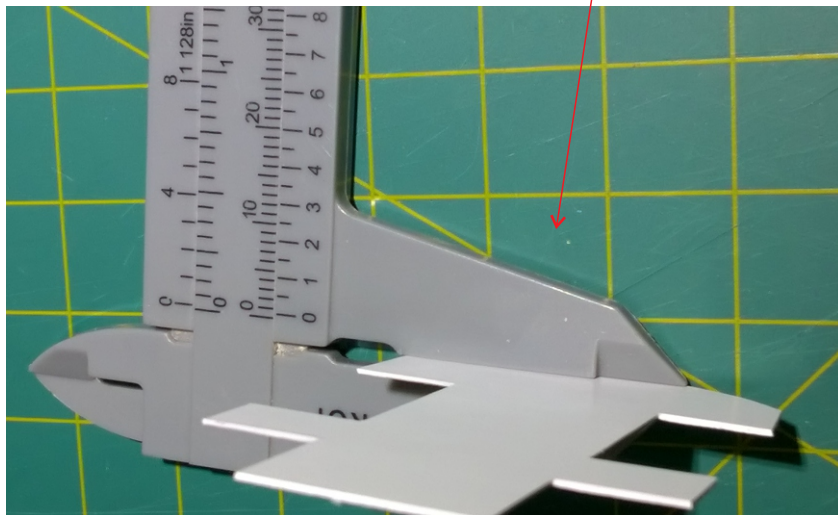

0,3mm tickness

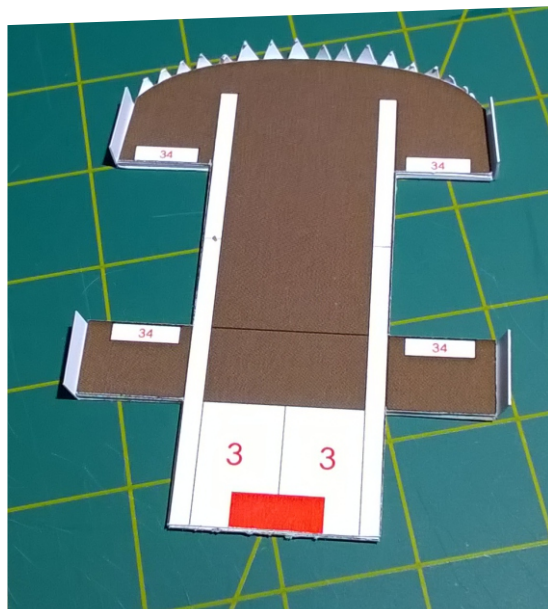

platform base

Kombi FOX
Ed 2 Rev1
1:43 A4 180g



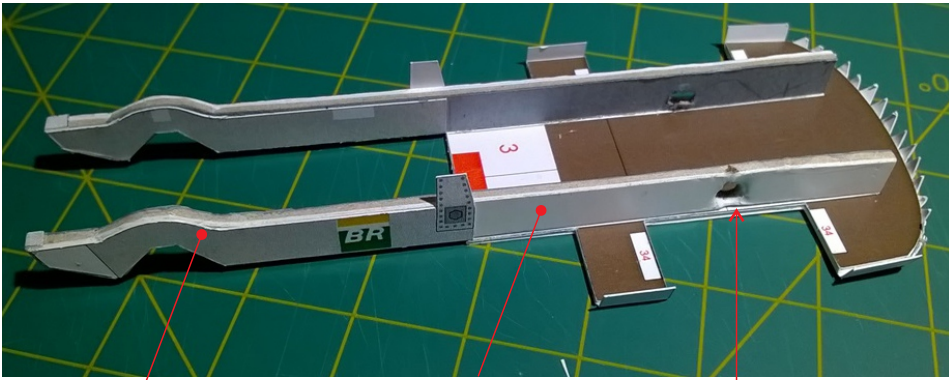

1

2

make a hole 2mm on the mark, then insert a 22mm length tube (2mm diameter)

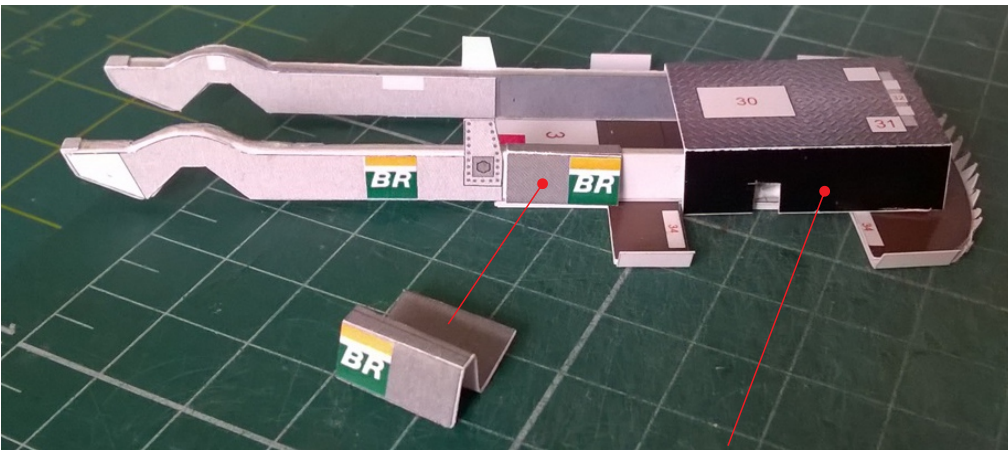

3

4



23 bracket

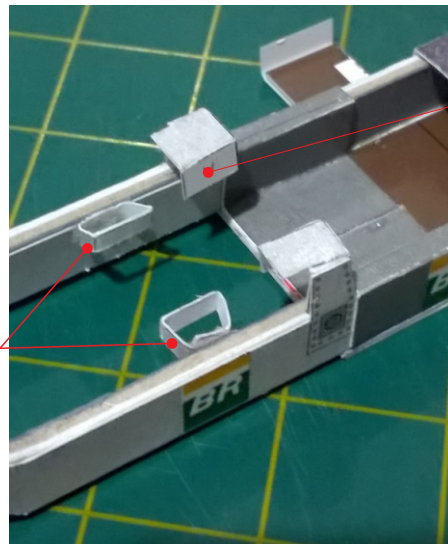

21

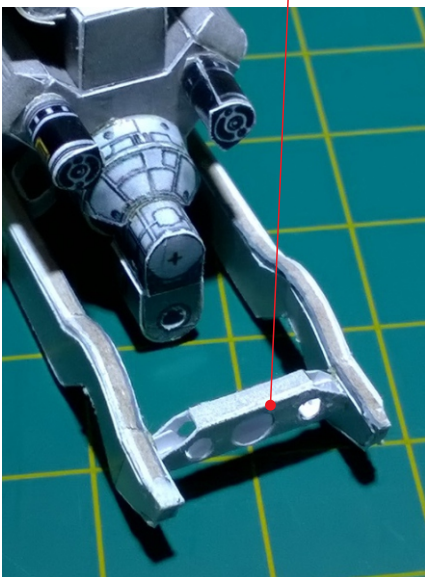
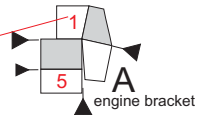

Kombi FOX
Ed 2 Rev1
1:43 A4 180g



16

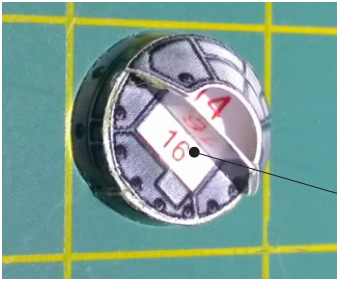

assembly
(11, 12, 13, 14, 15)

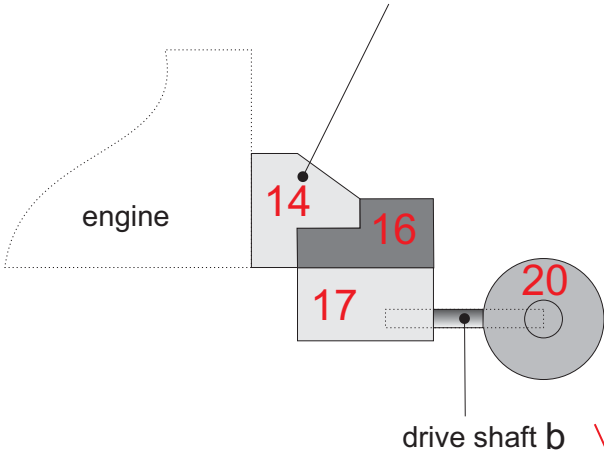
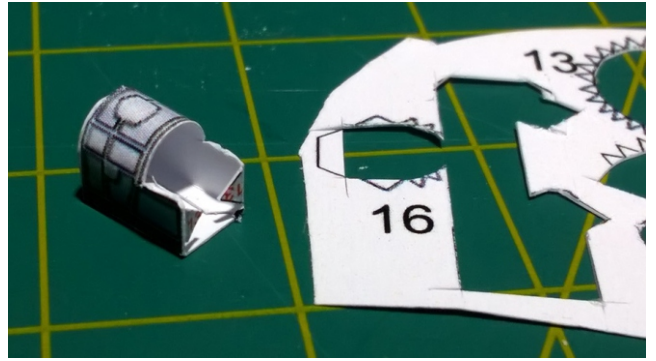

5b carter

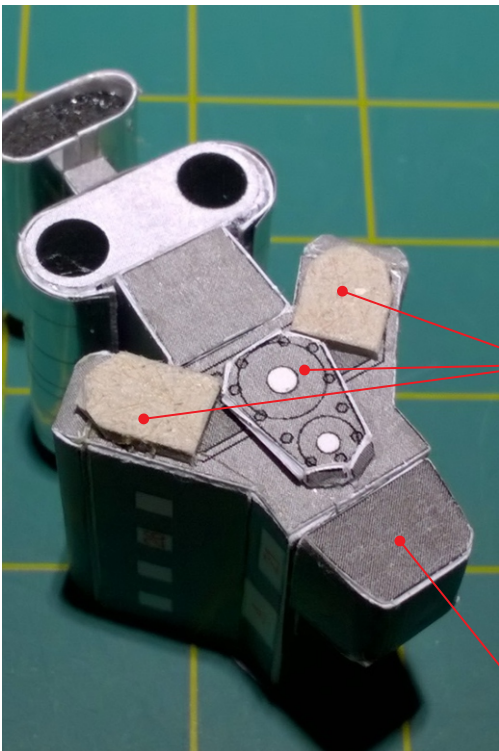

18 (or replace 18 by pieces
1,5mm tickness like these)

5b carter

Kombi FOX
Ed 2 Rev1
1:43 A4 180g





42

43

40

8

10

pulley 1mm tickness

drive belt

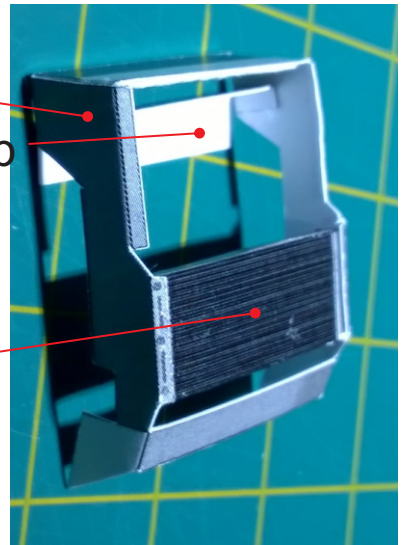

24

24b

25a



24b

25a

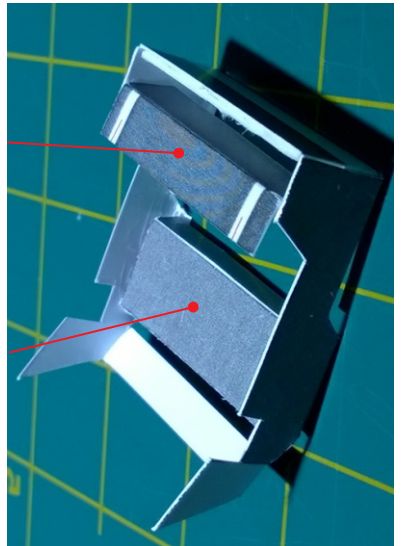

19

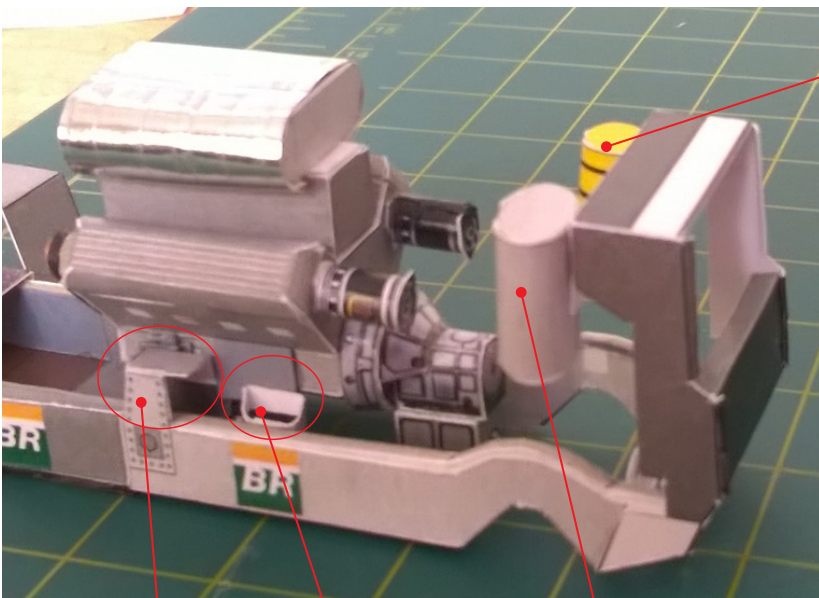

27

25

25a

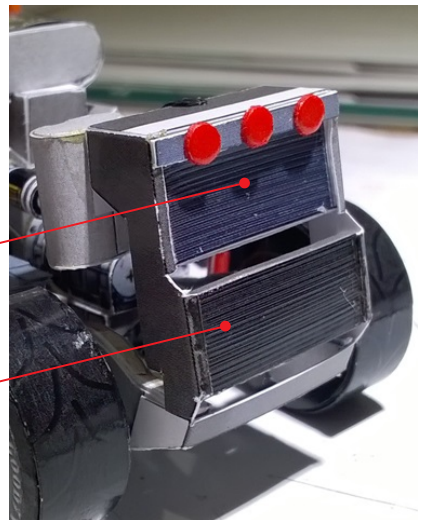

Engine anchor points 21

28

Kombi FOX
Ed 2 Rev1
1:43 A4 180g



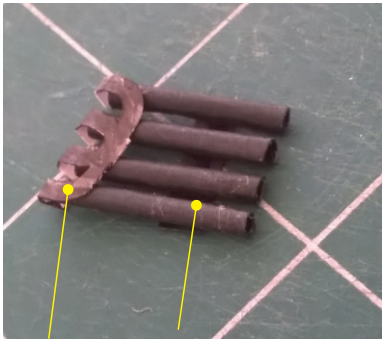

26

26a

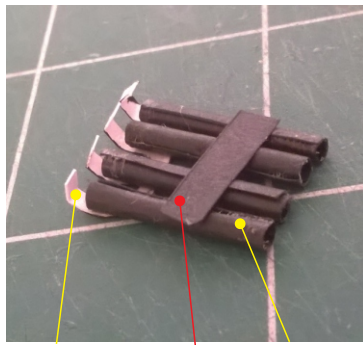

26

26a



26

make a bracket

make this bracket

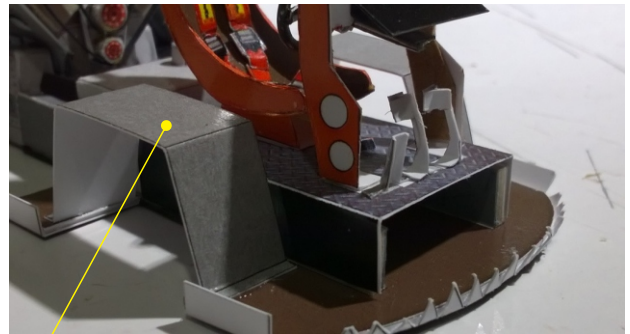
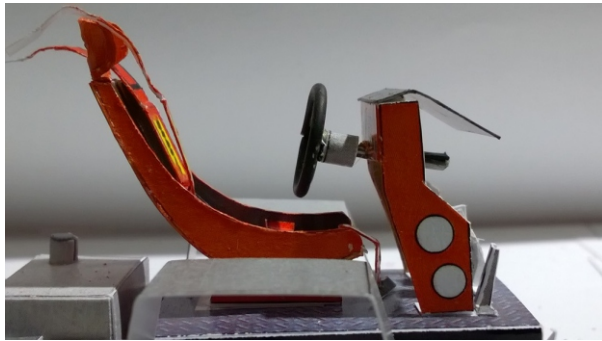
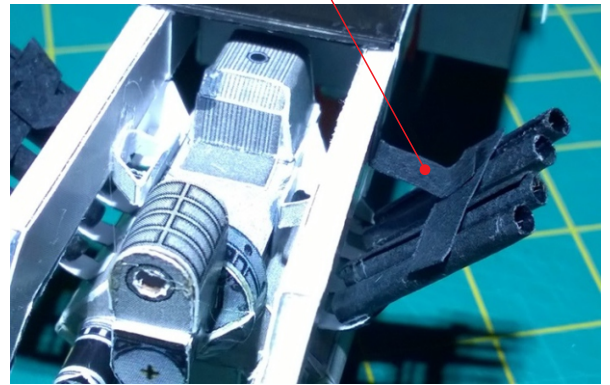
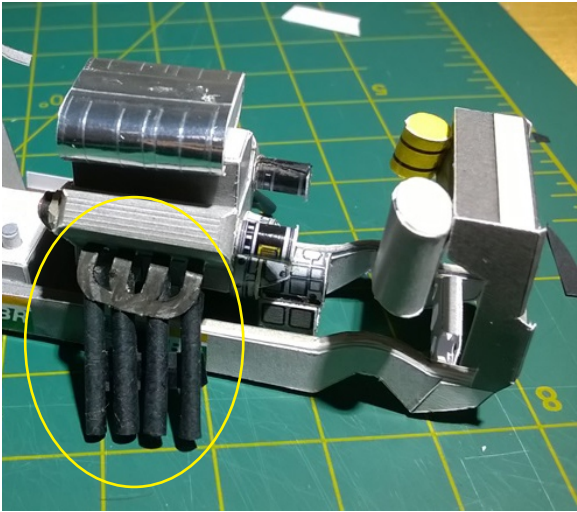

34

23

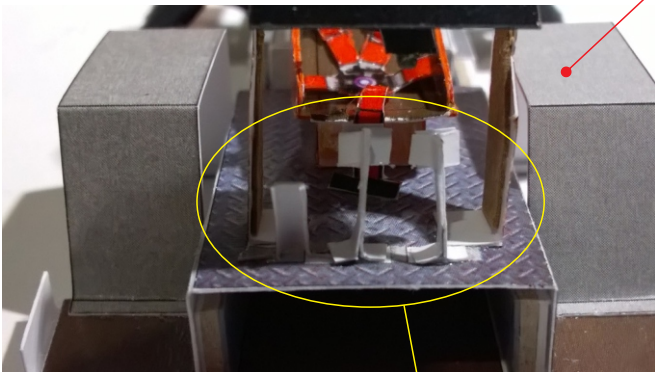

32



30

Kombi FOX
Ed 2 Rev1
1:43 A4 180g



REAR SUSPENSION

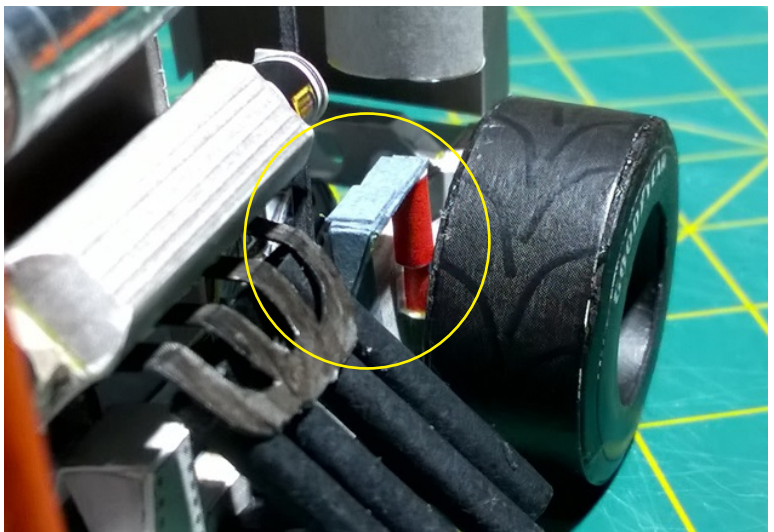
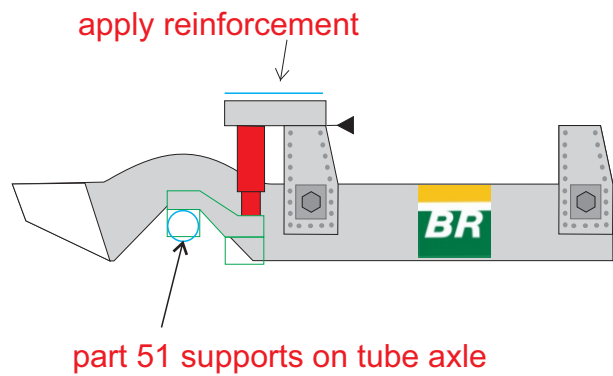
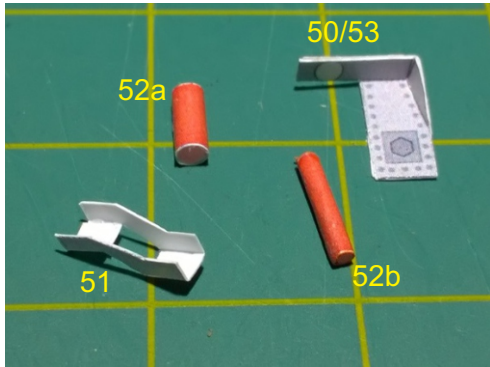

Tip: This set does not support the weight of the rear axle. It is just a figurative part.

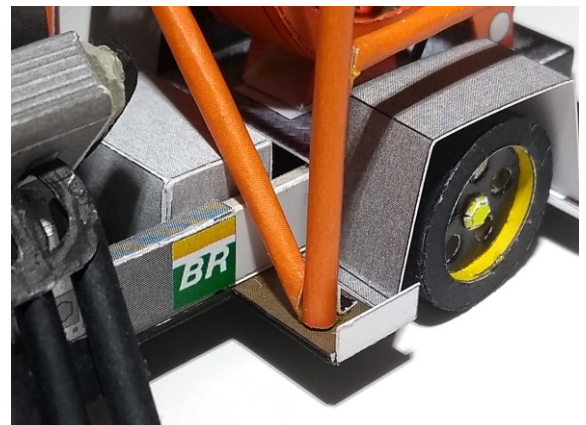
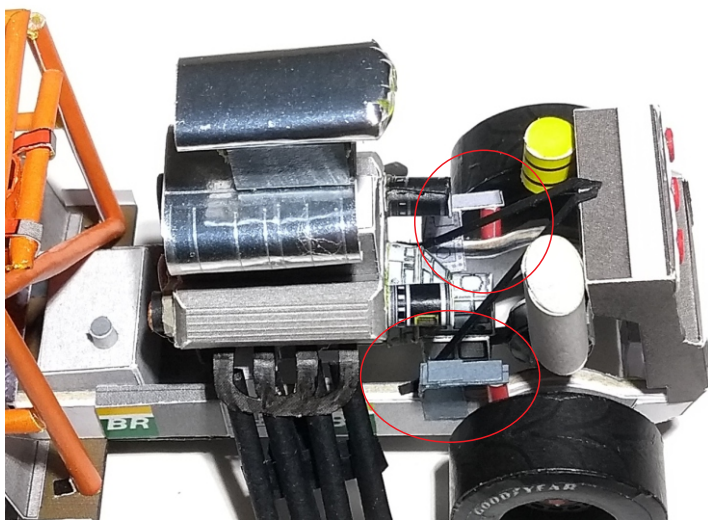

Kombi FOX
Ed 2 Rev1
1:43 A4 180g



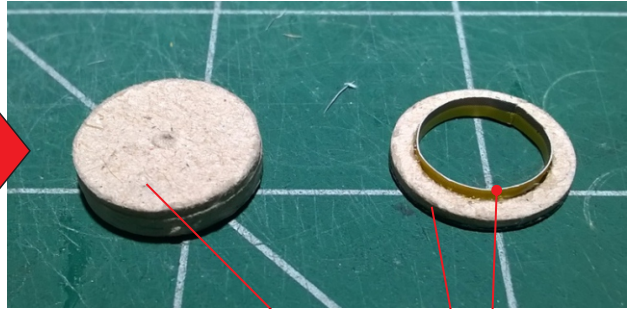

FRONT WHEELS

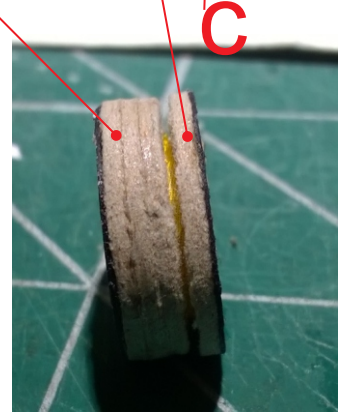
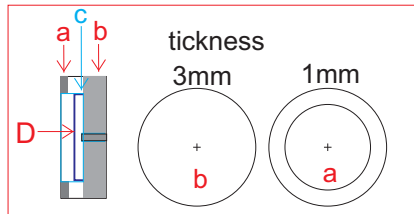

place an aluminum foil

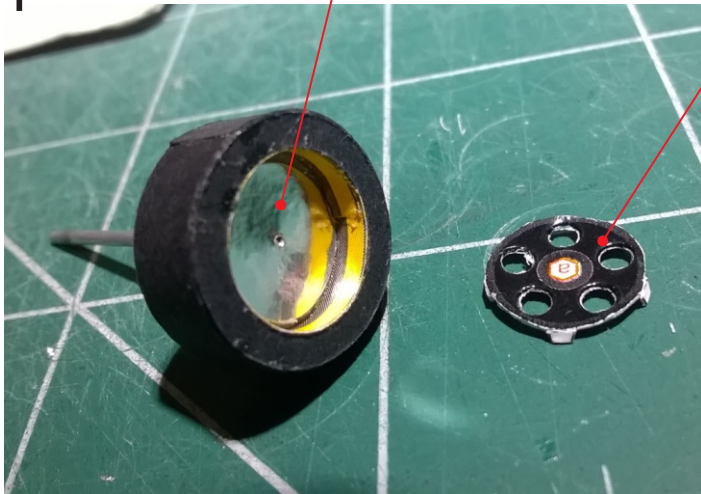

D



front axle 30mm lenght (wire)

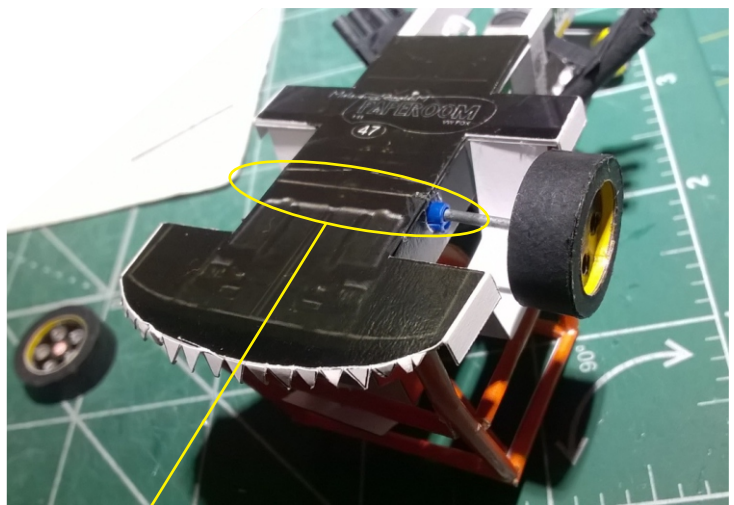
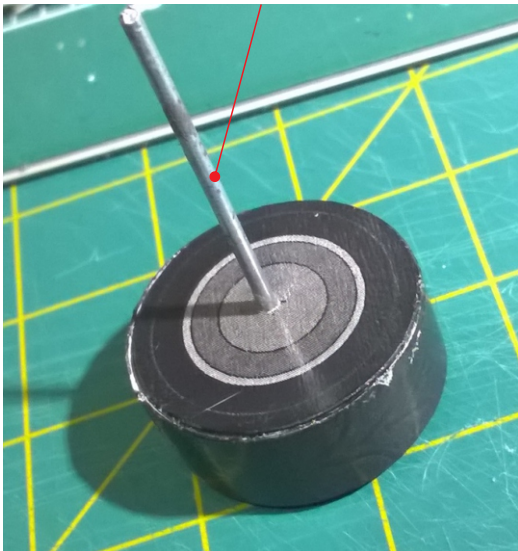

insert a tube 22mm lenght
2mm diameter

Kombi FOX
Ed 2 Rev1
1:43 A4 180g



REAR WHEELS

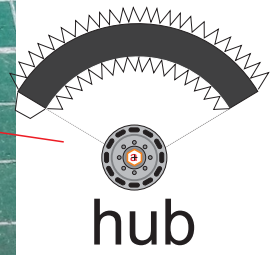
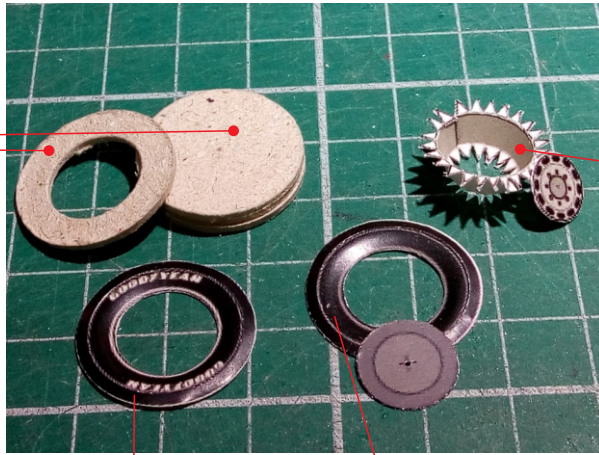
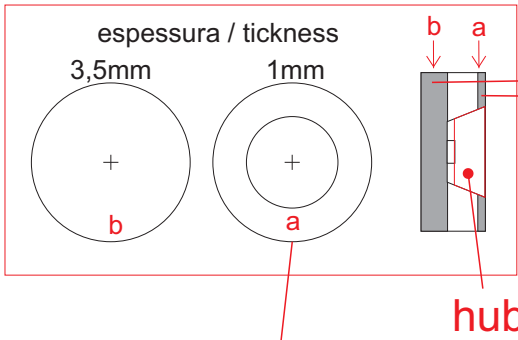

OPTIONAL remove center of back face if you want to round this face

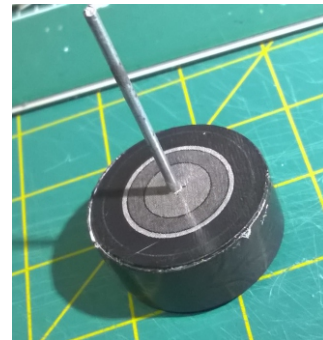
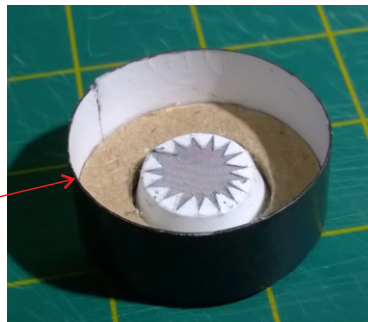
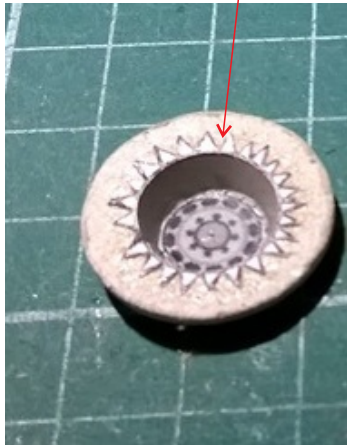

Make a center hole to insert the axle then insert (b) just facing the edge

insert a 34mm axle into one wheel only

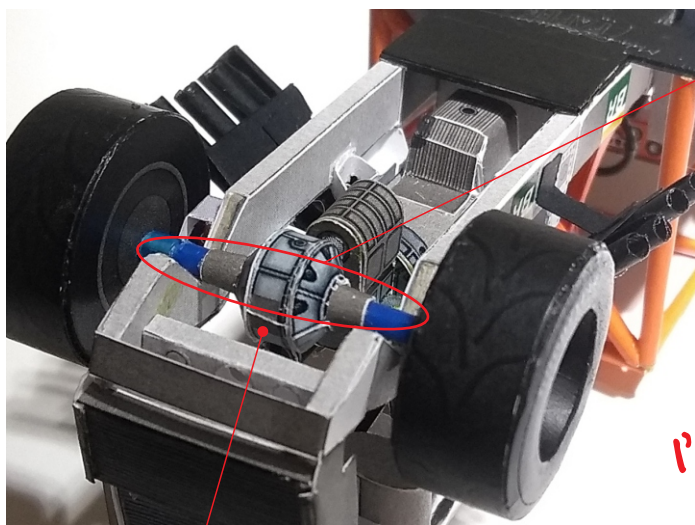

20

Insert a 27mm tube (2mm diameter) into the part 20 (sheet 2).

Pass the axle through the tube and fix the other wheel

I'm sure you'll get it !

Kombi FOX
Ed 2 Rev1
1:43 A4 180g



CAGE see pattern on sheet 3

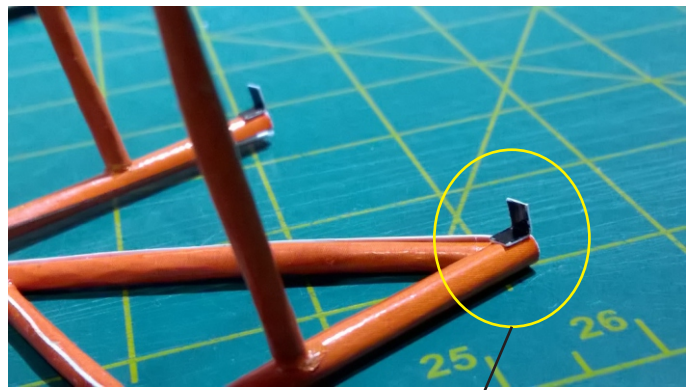
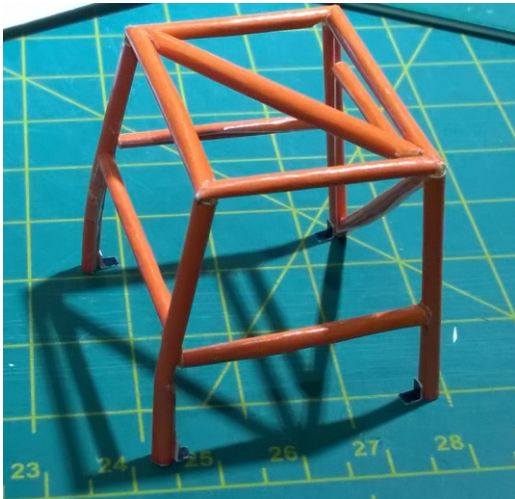

Install supports on the bases

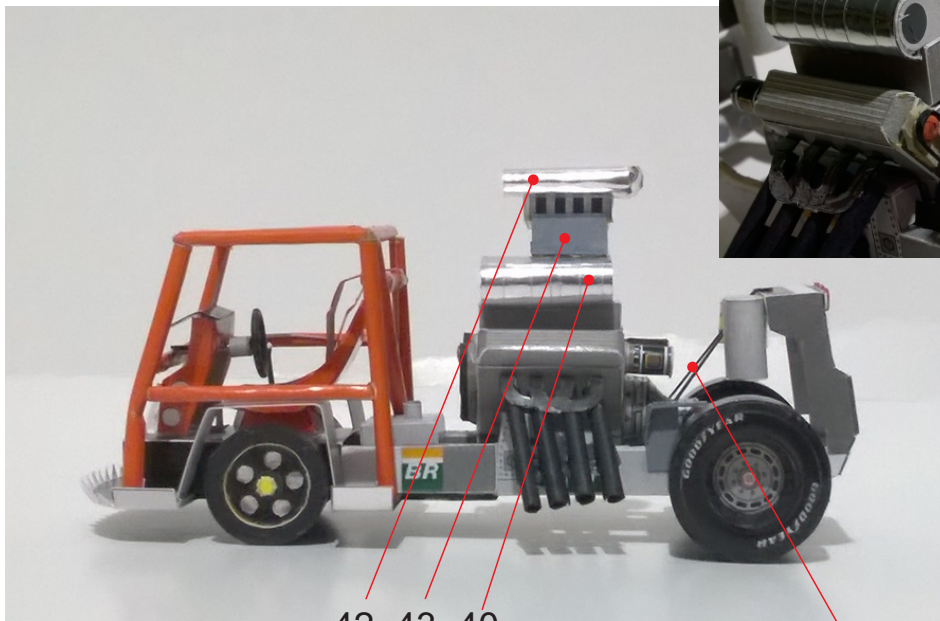

42 43 40



drive belt



60

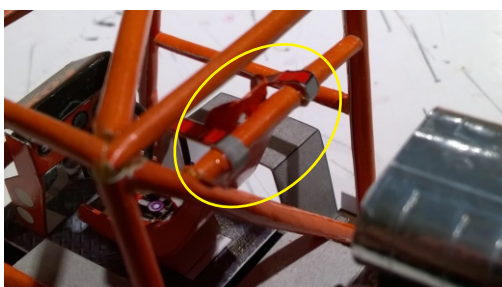

Seat belt fixing

Kombi FOX
Ed 2 Rev1
1:43 A4 180g



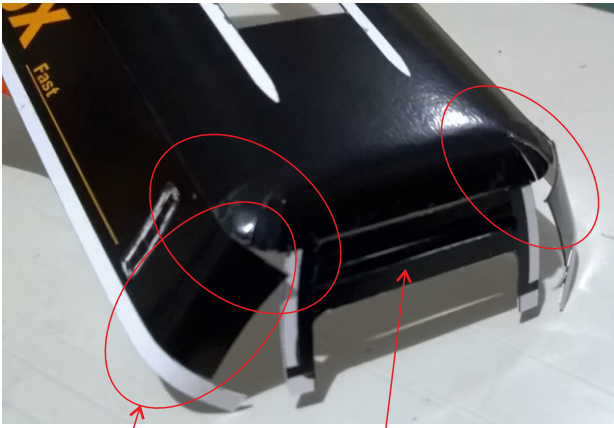

Bend and round these areas
 Cut along the lines and gently open the flaps outwards
 Make these parts, round them and install them

Install reinforcement and lining (sheet 4)

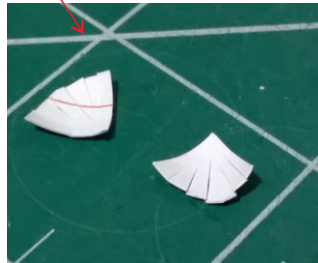
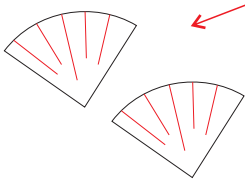

Prepare a plastic windshield and windshield frame.
 Bend each separate part and glue two parts into one piece.
 Install the windshield assembly to the vehicle body by
 attaching it to the side tab made in the body.

Do the top fixation last

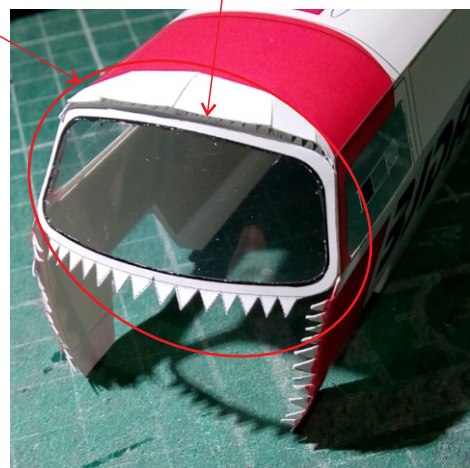
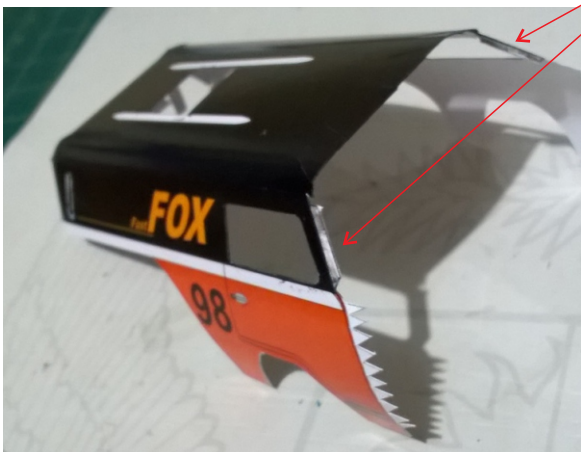

...then install the front panel as shown in the images next page

Kombi FOX
 Ed 2 Rev1
 1:43 A4 180g



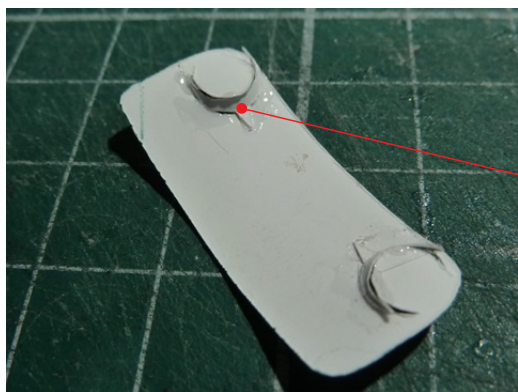

headlight frame

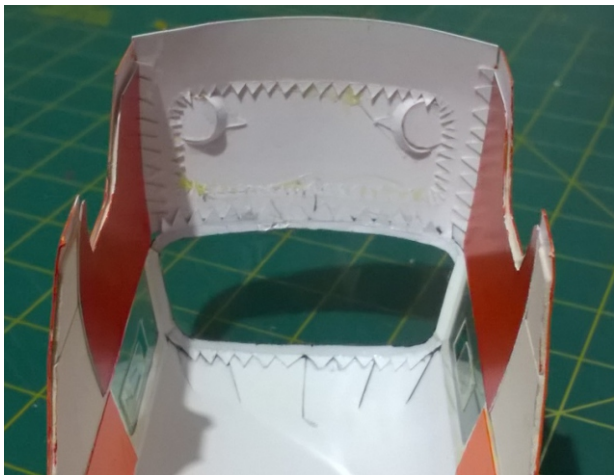
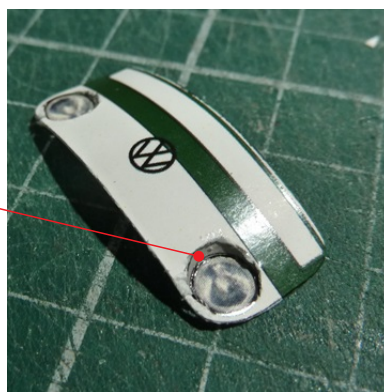

Kombi FOX
Ed 2 Rev1
1:43 A4 180g

